

# MULTI SERIES

## BIANCO HORIZONTAL MULTISTAGE PUMP WITH ELECTRONIC PUMP CONTROLLER

The pump is a horizontal multistage pressure system pump supplied wired and ready to install. Used especially for supplying water to domestic and commercial installations.

### FEATURES:

- The new nXt Pro intelligent electronic pump control is fitted and wired to the pump with plug and play leads for automatic starting, stopping and restarting after power loss or water loss
- The nXt Pro controller has an in-built check valve to prevent water back-flow through the pump
- Two operating modes: Mode 1 & Mode 2
- In MODE 1 the starting pressure can be adjusted and in MODE 2 both the starting and stopping pressures can be adjusted to fine tune the installation. A pressure tank is required for MODE 2.
- Corrosion resistant pump body, diffuser and impeller
- Mechanical shaft seal
- Comes complete with plug and play leads
- 240V single phase TEFC motor with in-built auto reset thermal overload

### MATERIALS IN CONTACT WITH DRINKING WATER PUMP

Pump Body:	304 Stainless Steel
Impeller:	304 Stainless Steel
Diffuser:	304 Stainless Steel
Mechanical Seal:	304SS/Silicon Carbide/Carbon
O Rings:	Nitrile

### CONTROLLER

Controller Body:	Glass reinforced Noryl
Diaphragm:	Butyl (TPV)
Ports, NRV:	Glass reinforced Noryl
Spring:	Stainless Steel
Pressure Sensor:	Brass OT58

### PACKAGE INFO

Weight:	16.6kg
Carton Dimensions:	460mm L x 230mm W x 420mm H

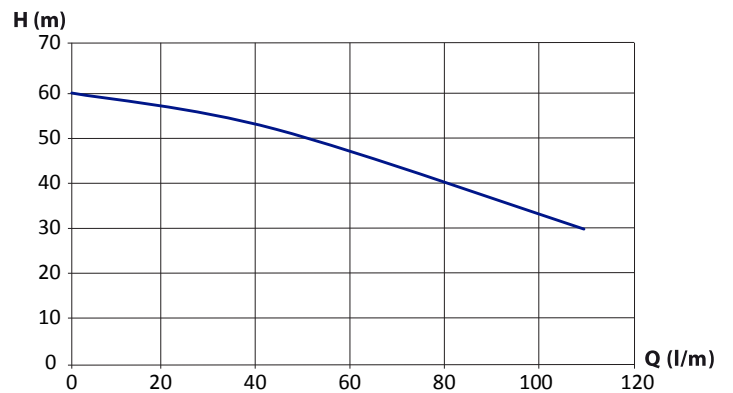

BIA-MULTI56NXTP

### SPECIFICATIONS

- Max Head (m): 60
- Max Flow: 108 lpm (6.5 m<sup>3</sup>/h)
- Motor Rating: 1.3kW (1.7hp)
- Max Amp: 8.64
- Volts: 240
- Ports: 1 1/4" BSPF x 1" BSPF
- Starting Pressure (bar): 2.2 - adjustable



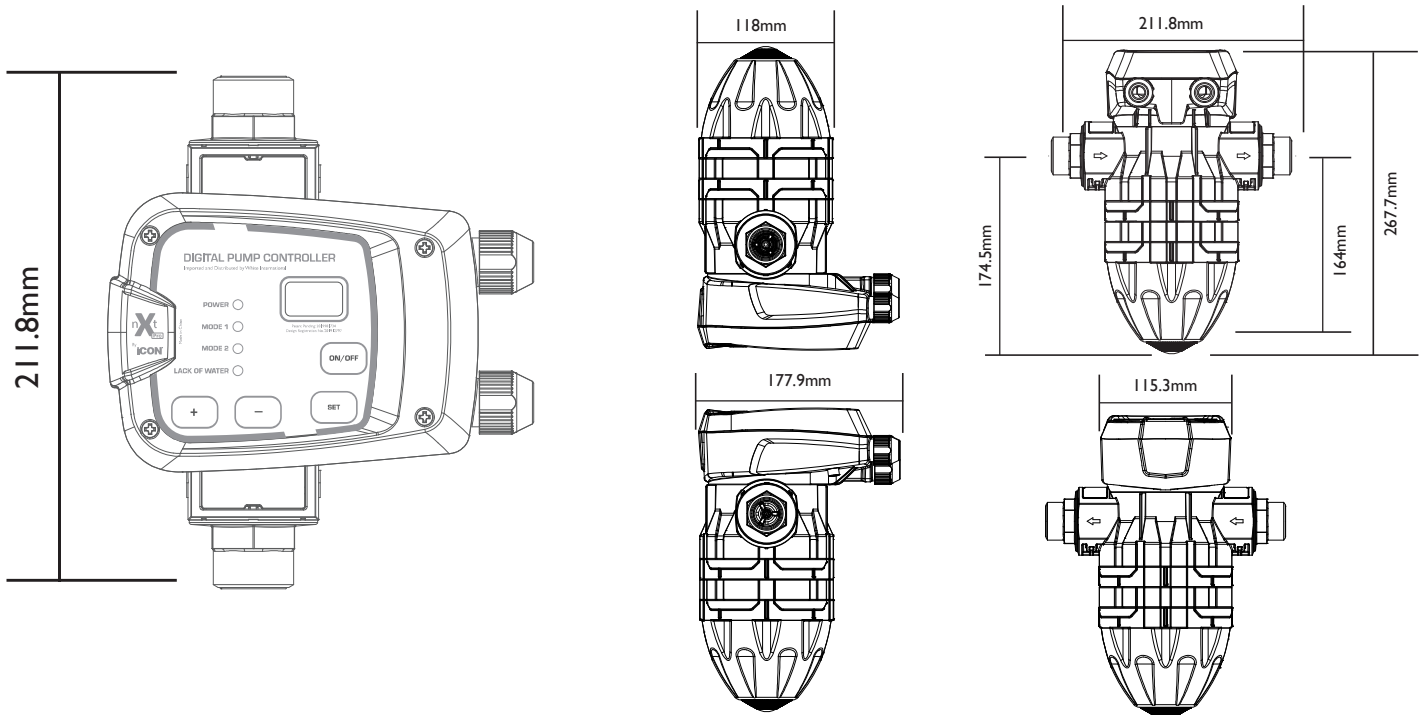

The nXt series of pump controls represents the next step in pressurised pump control.

Designed and tested in Australia to ensure operation in the toughest of environments, combining innovative technology with robust proven architecture to guarantee constant supply of pressurised water when and where you need it the most.

Ideal for pumps supplying clean, non-volatile liquids without fibers or solids in applications such as:

- Household water supply
- Irrigation
- Water transfer
- Washing systems
- Pressure boosting

#### Features:

- Digital display gives you a real time indication of system pressure
- Anti-cycle Protection
- Dry run protection with auto restart function that tests for water availability every 24hrs
- Anti-seize function if pump has not operated for last 24 hours
- Controller automatically restarts pump after a power failure
- Easy assembly and removal using push-n-connect fitting with U clip
- Complies to AS/NZ 4020 drinking water standard
- Over pressure protection turns pump off when 10 bar is reached
- Overload protection

#### Two operational modes:

- Mode One - Adjustable cut in pressure setting. Controller stops pump when flow drops.
- Mode Two - Adjustable cut in and cut out pressure. Shut down governed by pressure. Requires pressure tank.

	NXT PRO
Function	ON/OFF + Config
Modes	2
Size	2.2Kw
Rated Voltage	80-260V AC
Max Amps	16
Rated Power	2200w
Rating	IP65
Union Size	1"
Start Pressure	Adjustable
Stop Pressure	Adjustable
Max Pressure	10 bar (145PSI)
Max Liquid Temp	40°C
Cable to Pump	Plug and Play
Flylead for Pump	When sold as control only
Power Cable	10AMP
Communication	-
Accessories	15 AMP Cable
(Sold Separately)	1 1/4" Union Kit