

## LF LED Wall Light DESIGNER PREMIUM



PROJECT
CATALOG #
TYPE
NOTES

The LF is our LED under-the-cap hardscape wall light. It can easily be fitted between a block wall and capstone for a neat, clean installation. Due to its modular bracket design, the LF can even be installed under railings and existing construction.

### Quick Facts

- Die-cast brass housing
- Natural, powder coated, or antiqued brass finishes
- Lumileds® Integrated LEDs
- Compatible with Luxor® technology
- Phase and PWM dimmable
- Input voltage: 10-15V

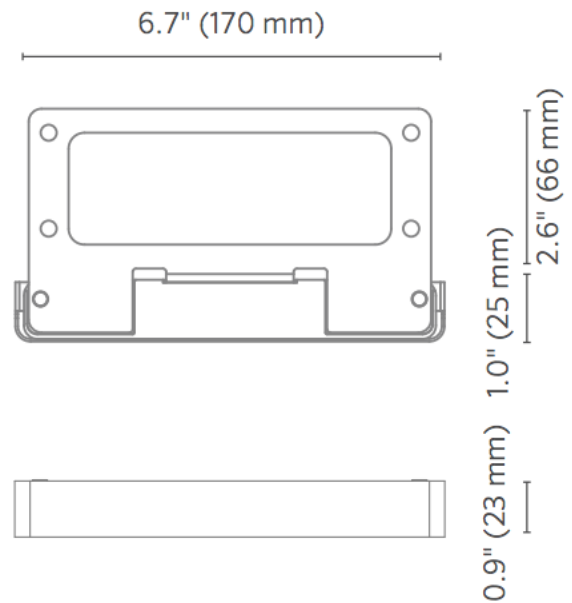

# LF LED Wall Light SPECIFICATIONS

Output	1LED	ZDC
Total Lumens <sup>†</sup>	95	34
Input Voltage	10 to 15V	11 to 15V
Input Power (W)	1.9	3.6
VA	2.2	4.3
Efficacy (Lumens/Watt)	52	21
Color Rendering Index (CRI)	84	80+
Max Candela	38	17.1
Dimming	PWM, Phase**	PWM, Phase**
Luxor Compatibility		
Default	Zoning	Zoning
ZD Option	Zoning/Dimming	--
ZDC Option	--	Zoning/Dimming/Color
Minimum Rated Life (L70 B10)	L70 (hrs) 72,000	55,000 Hrs
BUG Rating	B0-U0-G0	B0-U0-G0

<sup>†</sup> Measured using the 3,900K CCT lens. Multipliers for other CCTs include 0.80 (2,700K).

\*\* For optimal performance, use a trailing-edge, phase-cut dimmer.

# LF LED Wall Light SPECIFICATIONS

## FX Luminaire

FX Luminaire is an industry-leading manufacturer of landscape and architectural lighting products with a focus on the advancement of LED technology and digital lighting control with zoning, dimming, and color adjustment capabilities. We offer a full spectrum of specification-driven lighting fixtures that can be utilized to create elegant, cutting-edge landscape lighting systems for commercial or residential applications. Our products are available exclusively via our extensive professional distributor network.

## Materials

Die-cast C360 brass or A380 aluminum housing with stainless steel, brass, or copper faceplate (when applicable) and hardware.

## LED

Integrated module with Cree LEDs. Gold-plated connectors and conformal coated for maximum reliability and corrosion resistance. Proprietary on-board intelligent driver uses firmware-controlled temperature regulation, maximizing LED life. Field upgradeable and replaceable, the LEDs are rated to 50,000 hrs. Maximum drive current: 1 A.

## Optics

Polycarbonate color temperature adjustment lenses included with fixture: 2,700K (preinstalled), 3,900K (no lens). Color temperature lenses are field serviceable.

## Finish

Options of natural copper/brass, stainless steel finish, powder coated, or antiqued finish with brushed (Antique Bronze) or tumbled (Antique Tumbled) effect. Antique finishes sealed with a clear TGIC powder coat layer.

## Hardware

Stainless steel acorn nuts for tamper-resistance and proper adjustment.

## Wiring

18 AWG (1 mm); SPT-1W; 220°F (105°C); 300V; 10' (3 m) length.

## Sockets

Socket contains MoistureBlock™ technology, preventing moisture from wicking up into sealed areas of the fixture.

## Power

Input 10–15 VAC/VDC, 50/60 Hz. Remote transformer required (specify separately).

## Housing

Die-cast brass or aluminum housing with capacity for rectangular 1LED integrated LED.

## Weight

1.0 lb. (0.5 kg)

## Lens

Frosted polycarbonate lens with high tolerance for thermal expansion, stress, and abuse.

## Ambient Operating Temperature

0°F to 140°F (-18°C to 60°C)

## Sustainability Installation Requirements

Designed for installation in the downward lighting direction only.















## Control

ZD and ZDC options utilize Luxor technology to zone light fixtures in up to 250 groups, dim each group in 1% increments between 0 and 100%, or change to one of 30,000 colors with RGBW LEDs. Select the ZD option for zoning/dimming or ZDC for zoning/dimming/color. Standard fixture is zoneable with Luxor.

## Warranty Listings



# LF LED Wall Light ORDERING INFORMATION

Fixture	Luxor Option	Lamp	Color Temp	Compliance	Finish
LF	[default] Zone	1 LED 2.0W/2.4VA	W Warm (2700K)	[default] North America (UL-listed)	BSAB Antique Bronze on Brass 
	ZD Zone/Dim	[default ZDC option] 3.6W/4.3VA	C Cool (3900K)	e Int'l (CE Certified)	BSAT Antique Tumbled on Brass 
	ZDC Zone/Dim/Color		[default ZDC option] RGBW		CUAB Antique Bronze on Copper  CUAT Antique Tumbled on Copper  CU Copper  BS Natural Brass  SS Stainless Steel  BZ Bronze Metallic  DG Desert Granite  WI Weathered Iron  SB Sedona Brown  FB Black  FW Flat White  SV Silver 



EXAMPLE FIXTURE CONFIGURATION: LF-ZD-1LED-W-BZ

\*Includes Mounting Plate (755300)

## LF-1LED - Illuminance at a Distance

Distance	Center Beam fc	Beam Width	
Feet (Meters)	Foot-Candles (Lux)	Vertical: 100.7 °	Horizontal: 107.0 °
1' (0.3 m)	37 fc (398 lx)	2.4 ft (0.7 m)	2.7 ft (0.8 m)
2.0' (0.6 m)	9.3 fc (100 lx)	4.8 ft (1.5 m)	5.4 ft (1.6 m)
3' (0.9 m)	4.1 fc (33 lx)	7.2 ft (2.2 m)	8.1 ft (2.5 m)
4.0' (1.2 m)	2.3 fc (25 lx)	9.6 ft (2.9 m)	10.8 ft (3.3 m)
5.0' (1.5 m)	1.5 fc (16 lx)	12.1 ft (3.7 m)	13.5 ft (4.1 m)
6.0' (1.8 m)	1 fc (11 lx)	14.5 ft (4.4 m)	16.5 ft (5.0 m)

## LF ZDC - Illuminance at a Distance

Distance	Center Beam fc	Beam Width	
Feet (Meters)	Foot-Candles (Lux)	Vertical: °	Horizontal: °

# LF LED Wall Light ORDERING INFORMATION

POWER OPTIONS: Specify Separately

Power	Catalog No.		Power	Catalog No.	
Plug-in transformer, 6W	MT-6W		Step-Down Transformer, UV (120/277 V to 12 V)	ST-UV	
Lighting Fixture Surge Module	SURGE-MOD				