

Operator's manual
HUSQVARNA AUTOMOWER®
420/430X/440/450X



EN, English

Read the operator's manual carefully and make sure that you understand the instructions before you use the product.

Contents

1 Introduction	
1.1 Introduction.....	3
1.2 Product overview	4
1.3 Symbols on the product.....	5
1.4 Symbols on the display.....	5
1.5 Symbols on the battery.....	6
1.6 General manual instructions.....	6
1.7 Menu structure overview 1.....	7
1.8 Menu structure overview 2.....	8
1.9 Menu structure overview 3.....	9
1.10 Display.....	10
1.11 Keypad.....	10
2 Safety	
2.1 Safety definitions.....	11
2.2 General safety instructions.....	11
2.3 Safety instructions for installation.....	12
2.4 Safety instructions for operation.....	12
2.5 Safety instructions for maintenance.....	12
2.6 Battery safety.....	12
2.7 How to lift and move the product.....	13
3 Installation	
3.1 Introduction - Installation.....	14
3.2 Main components for installation.....	14
3.3 General preparations.....	14
3.4 Before the installation of the wires.....	14
3.5 Installation of the product.....	19
3.6 To put the wire into position with stakes.....	20
3.7 To bury the boundary wire or the guide wire.....	21
3.8 To extend the boundary wire or the guide wire... ..	21
3.9 After the installation of the product.....	21
3.10 Product settings.....	22
3.11 Automower® Connect app.....	22
3.12 Product settings with keypad and display.....	22
4 Operation	
4.1 Main switch.....	33
4.2 To start the product.....	33
4.3 Operating modes - Start.....	33
4.4 To park the product.....	34
4.5 To stop the product.....	34
4.6 To switch off the product.....	34
4.7 To charge the battery.....	34
5 Maintenance	
5.1 Introduction - maintenance.....	35
5.2 Clean the product.....	35
5.3 Replacement of the blades.....	36
5.4 Battery.....	36
5.5 Winter service.....	36
6 Troubleshooting	
6.1 Introduction - troubleshooting.....	37
6.2 Fault messages.....	37
6.3 Information messages.....	42
6.4 Indicator lamp in the charging station.....	44
6.5 Symptoms.....	45
6.6 Find breaks in the loop wire.....	46
7 Transportation, storage and disposal	
7.1 Transportation.....	49
7.2 Storage.....	49
7.3 Disposal.....	49
8 Technical data	
8.1 Technical data.....	50
8.2 Registered trademarks.....	52
9 Warranty	
9.1 Warranty terms.....	53

1 Introduction

1.1 Introduction

Serial number:
Product number:
PIN code:

The serial number and the product number are on the product rating plate and on the product carton.

- Register your product on www.husqvarna.com. Enter the serial number of the product, the product number and the date of purchase to register your product.

1.1.1 Support

For support about the product, speak to your Husqvarna servicing dealer.

1.1.2 Product description

Note: Husqvarna regularly updates the appearance and function of the products. Refer to *Support on page 3*.

The product is a robotic lawn mower. The product has a battery power source and cuts the grass automatically. It continuously alternates between mowing and charging. The movement pattern is random, which means that the lawn is mowed evenly and with less wear. The boundary wire and the guide wire controls the movement of the product within the work area. Sensors in the product senses when it is approaching the boundary wire. The front of the product always passes the boundary wire by a specific distance before the product turns around. When the product hits an obstacle or approaches the boundary wire the product selects a new direction.

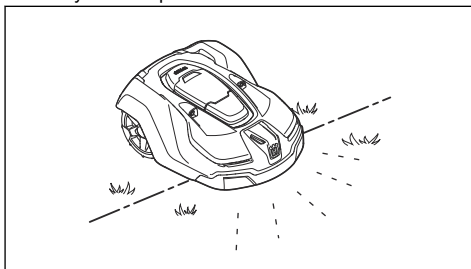

The operator selects the operation settings with the keys on the keypad. The display shows the selected and possible operation settings, and the operation mode of the product.

1.1.2.1 Mowing technique

The product is emission free, easy to use and saves energy. The frequent cutting technique improves the grass quality and decreases the use of fertilizers. Collection of grass is not necessary.

1.1.2.2 Find the charging station

The product operates until the battery state of charge is low, then the product starts to go to the charging station. The guide wire is put from the charging station to a remote part of the work area or through a narrow passage. The guide wire is connected with the boundary wire to make it easier and faster for the product to find the charging station.

1.1.2.3 Automower® Connect

Automower® Connect is a mobile application that makes it possible to select the operation settings remotely. Refer to *Automower® Connect app on page 22*.

1.2 Product overview

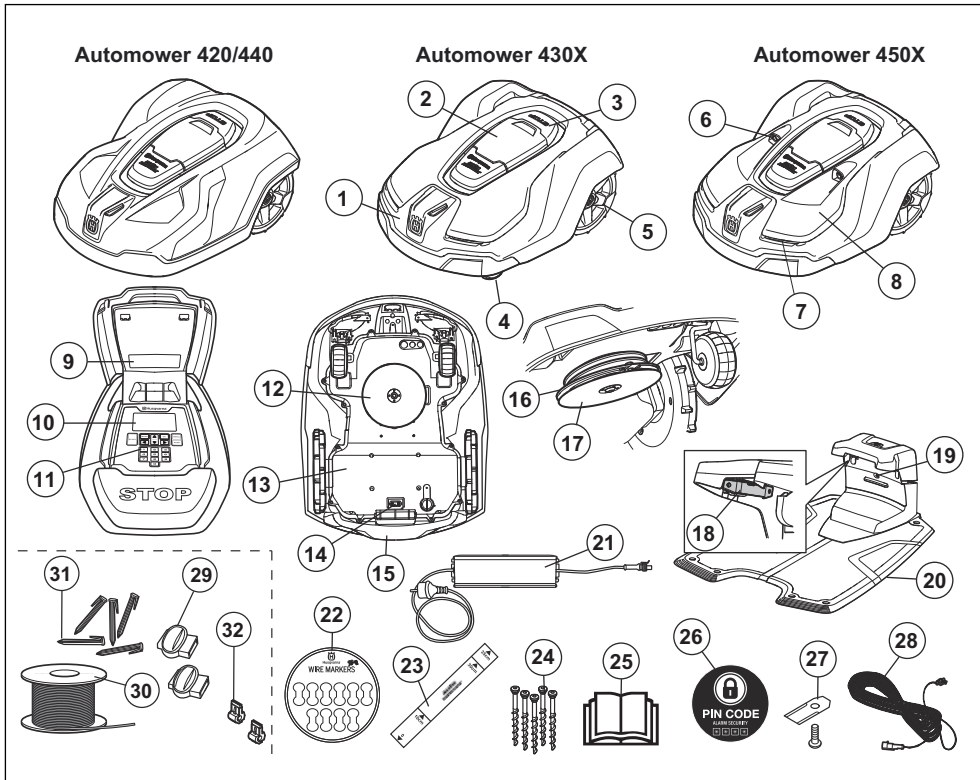

The numbers in the figure represent:

- | | |
|--|--|
| 1. Body | 16. Blade disc |
| 2. Hatch to display and keypad | 17. Skid plate |
| 3. Stop button | 18. Contact plates |
| 4. Front wheels | 19. LED for operation check of the charging station and boundary wire |
| 5. Rear wheels | 20. Charging station |
| 6. Ultrasonic sensors | 21. Power supply (the appearance may differ depending on market) |
| 7. Headlights | 22. Cable markers |
| 8. Replaceable cover | 23. Measurement gauge when installing the boundary wire (the measurement gauge is broken loose from the box) |
| 9. Rating plate (incl. product identification code) | 24. Screws for securing the charging station |
| 10. Display | 25. Operator's Manual and Quick Guide |
| 11. Keypad | 26. Alarm decal |
| 12. Cutting system | 27. Extra blades |
| 13. Chassis box with electronics, battery and motors | 28. Low voltage cable |
| 14. Main switch | |
| 15. Handle | |

- 29. Couplers for the loop wire ¹
- 30. Loop wire for boundary loop and guide wire ²
- 31. Stakes ³
- 32. Connectors for the loop wire ⁴

1.3 Symbols on the product

These symbols can be found on the product. Study them carefully.



WARNING: Read the user instructions before operating the product.



WARNING: Disable the product before working on or lifting the product.



WARNING: Keep a safe distance from the product when operating. Keep your hands and feet away from the rotating blades.



WARNING: Do not ride on the product. Do not put your hands or feet close to or under the product.

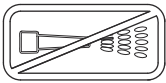

Do not use a high-pressure washer or even running water to clean the product.

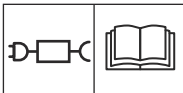

Use a detachable power supply as defined on the rating label next to the symbol.



This product complies with the applicable EU Directives.



This product complies with the applicable UK Directives.



It is not permitted to dispose this product as normal household waste. Ensure that the product is recycled in accordance with local legal requirements.



The chassis contains components which are sensitive to electrostatic discharge (ESD). The chassis must also be resealed in a professional manner. For these reasons the chassis shall only be opened by authorized service technicians. A broken seal can result in the entire or parts of the guarantee no longer being valid.

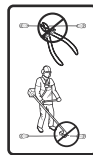

The low-voltage cable must not be shortened, extended or spliced.
Do not use a trimmer nearby the low-voltage cable. Be careful when trimming edges where the cables are placed.

1.4 Symbols on the display



In the schedule menu you can set when the product will cut the lawn.



In the cutting height menu you can set the cutting height of the product.



In the security menu you can select between 3 security levels for the product.



In the messages menu you can find the *Fault messages* and *Info messages* of the product.



The Weather timer function automatically adapts the cutting intervals to the grass growth.

¹ Is a part of the Installation kit which is purchased separately.

² Is a part of the Installation kit which is purchased separately.

³ Is a part of the Installation kit which is purchased separately.

⁴ Is a part of the Installation kit which is purchased separately.



In the installation menu you can set manual settings for the installation of the product.



In the settings menu you can set the general settings of the product.



In the accessories menu you can set the settings for the accessories of the product.



The schedule is set for the product to not cut the grass.



The product overrides the schedule.



The battery indicator shows the charge level of the battery. When the product charges the symbol flashes.



The product is in the charging station and the battery is fully charged.



The product is set in ECO-mode.



Bluetooth® wireless communication with your mobile device.



The GPS-supported navigation is active. Flashes as it collects GPS information.



The GPS-supported navigation is not active.



The signal strength of the GPRS reception.



Problem with the connection to the Internet server.



Problem with the SIM card or the module.

1.5 Symbols on the battery



WARNING: Lithium-ion batteries can explode or cause fire if disassembled, short-circuited or handled roughly. Do not expose to water, fire or high temperature.



Read the user instructions.



Do not discard the battery into fire and do not expose the battery to a heat source.



Do not immerse the battery into water.

1.6 General manual instructions

The following system is used in the Operator's Manual to make it easier to use:

- Text written in *italics* is a text that is shown in the display or is a reference to another section in the Operator's Manual.
- Text written in **bold** is one of the buttons on the product.

1.7 Menu structure overview 1

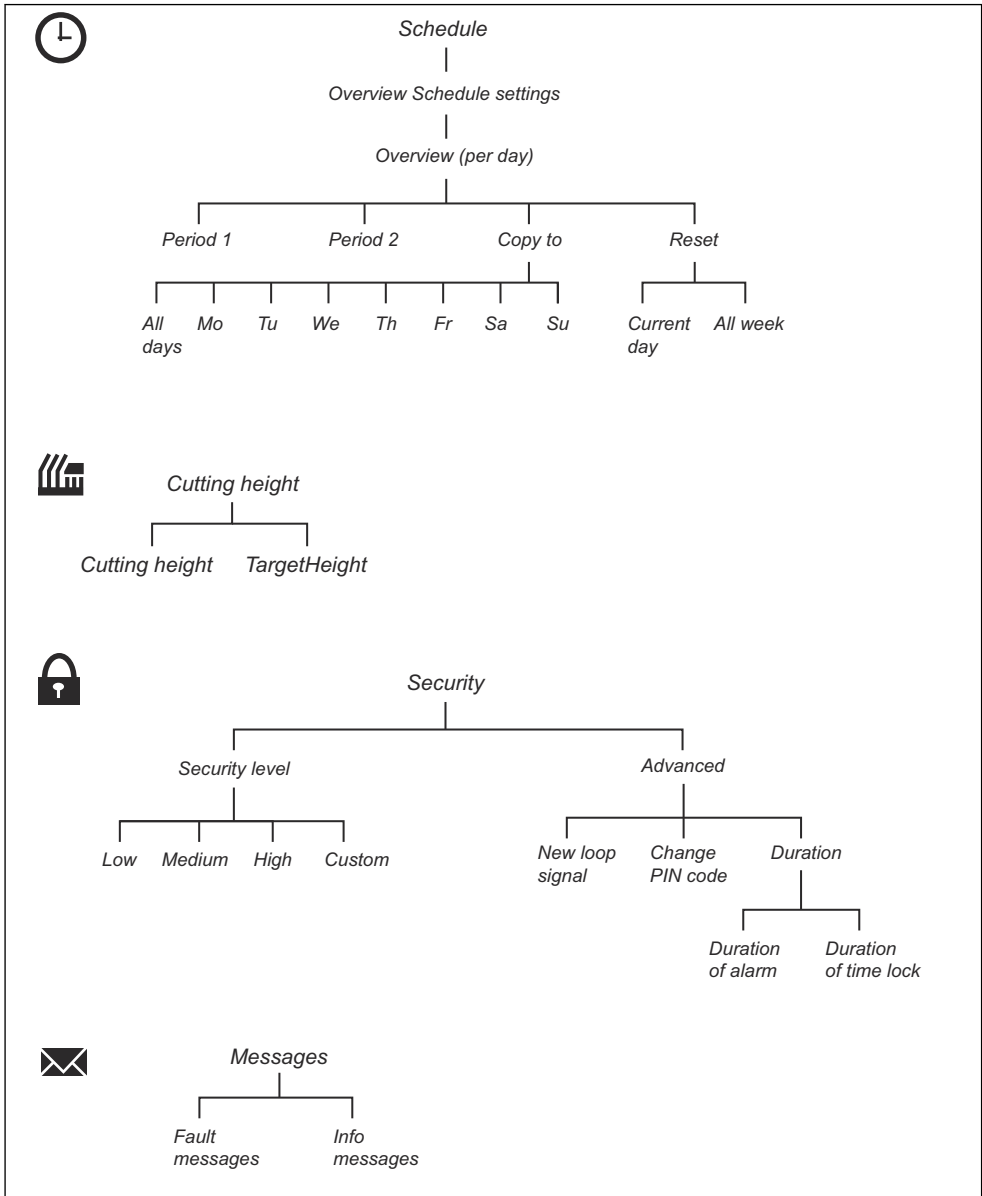

1.8 Menu structure overview 2

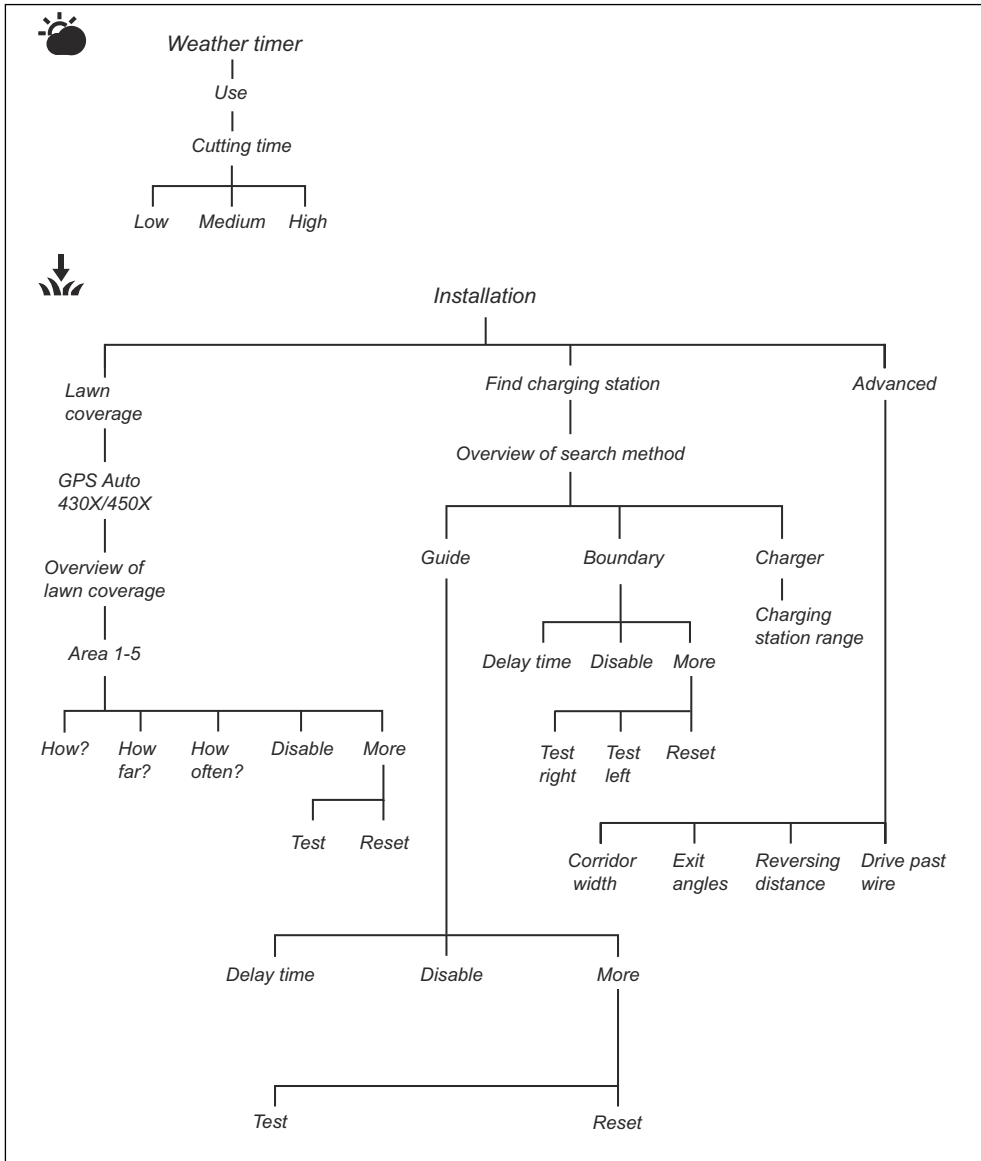

1.9 Menu structure overview 3

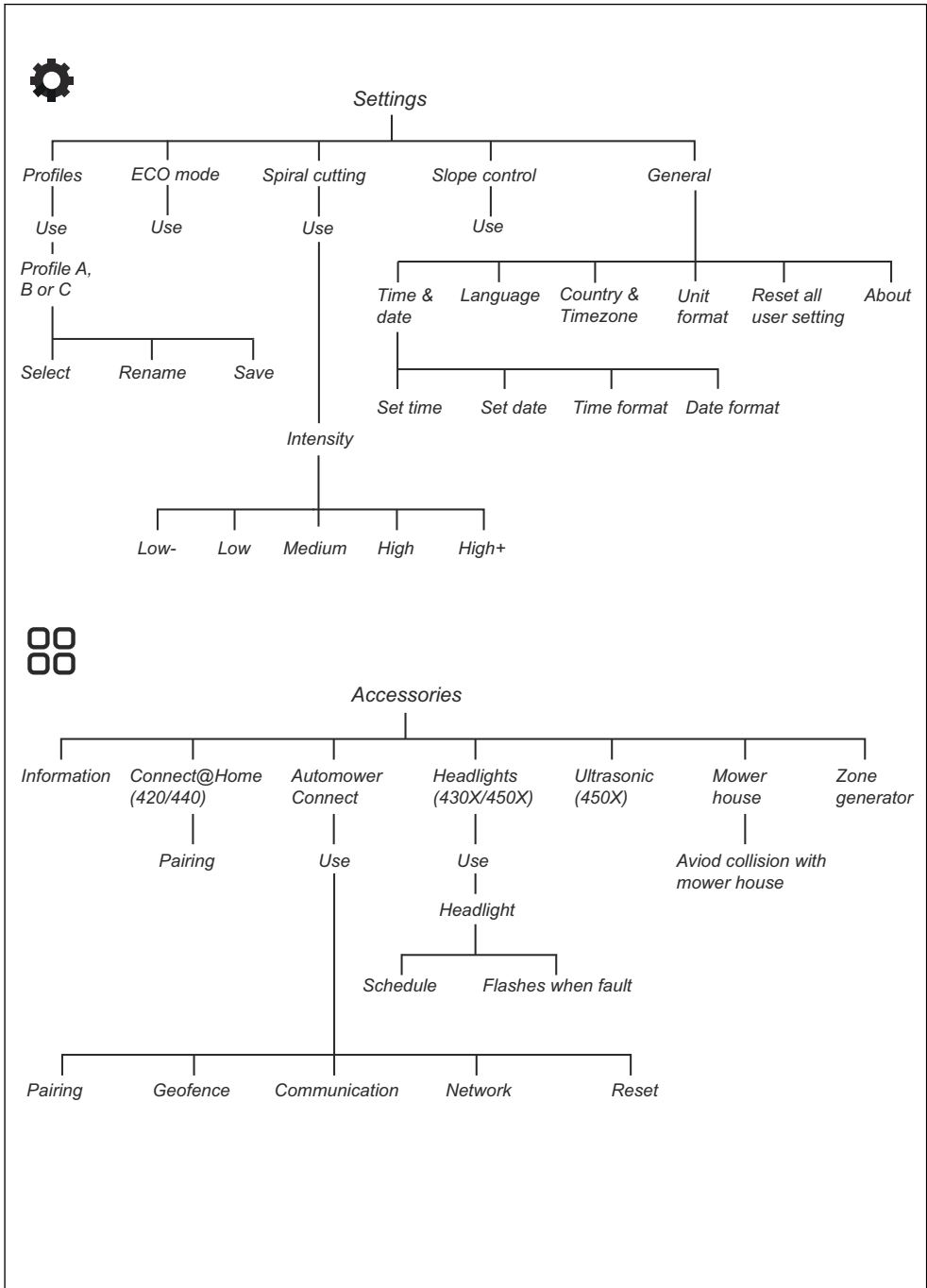

1.10 Display

The display on the product shows information and settings of the product.

To access the display, push the **STOP** button.

1.11 Keypad

Use the keypad on the product to navigate in the menu.

To access the keypad, push the **STOP** button.

- Use the **START** button (A) to start the operation of the product.
- Use the **BACK** button (B) to move up in the menu lists.
- Use the **arrow** buttons (C) to navigate in the menu.
- Use the **OK** button (D) to confirm the settings you select in the menus.
- Use the **MENU** button (E) to go to the main menu.
- Use the **PARK** button (F) to send the product to the charging station.
- Use the **number** buttons (G) to enter PIN code, time and date.

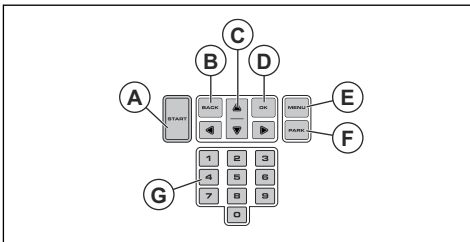

2 Safety

2.1 Safety definitions

Warnings, cautions and notes are used to point out specially important parts of the manual.



WARNING: Used if there is a risk of injury or death for the operator or bystanders if the instructions in the manual are not obeyed.



CAUTION: Used if there is a risk of damage to the product, other materials or the adjacent area if the instructions in the manual are not obeyed.

Note: Used to give more information that is necessary in a given situation.

2.2 General safety instructions



WARNING: Read the warning instructions that follow before you use the product.

- Read the Operator's manual carefully and make sure you understand the instructions before you use the product. Keep for future reference.
 - This appliance is not intended for use by children or persons with reduced physical, sensory or mental capabilities (that could affect a safe handling of the product), or lack of experience and knowledge, unless they have been given supervision or instruction concerning use of the appliance by a person responsible for their safety. However, EU requirements allows this appliance to be used by children aged from 8 years and above and persons with reduced physical, sensory or mental capabilities or lack of experience and knowledge, if they have been given supervision or instruction concerning use of the appliance in a safe way and understand the hazards involved. Children shall not play with the appliance. Cleaning and user maintenance shall not be made by children without supervision.
 - The product must only be used with the equipment recommended by Husqvarna. All other types of use are incorrect.
 - Do not use the product when persons, especially children, or animals are in the work area.
 - Warning signs must be put around the work area of the product if it operates in public areas. The signs must have the text that follows: Warning!
- Automatic lawn mower! Keep away from the machine! Supervise children!
- Do not touch moving hazardous parts, such as the blade disc, before it has come to a complete stop.
 - Set the product to OFF before you clear a blockage, do maintenance or examine the product, and if the product starts to vibrate abnormally. Examine the product for damage before you start the product again. Do not use the product to it is defective.
 - If an injury or accident occur, get medical aid.
 - Do not put power supply cable and extension cable in the work area. This can cause damage to the cables.
 - Do not connect a damaged cable or plug, or touch a damaged cable, before it is disconnected from the power outlet. Disconnect the plug from the power outlet if the cable becomes damaged while in operation. A worn or damaged cable increases the risk of electrical shock. A damaged cable must be replaced by service personnel.
 - When you connect the power supply to the power outlet, use a residual-current device (RCD) with a tripping current of maximum 30 mA.
 - Only charge the product in the included charging station. For safe disposal of the battery, refer to *Disposal on page 49*. Incorrect use may result in electric shock, overheating or leaking of corrosive liquid from the battery. In the event of leakage of electrolyte, flush with water/neutralizing agent. Get medical aid if corrosive liquid comes in your eyes.
 - Use only original batteries recommended by Husqvarna. Product safety cannot be guaranteed with other than original batteries. Do not use non-rechargeable batteries.
 - Follow the installation instructions that includes to specify the work area, refer to *Installation on page 14*.
 - Follow the instructions about to start and operate the product, refer to *Operation on page 33*.
 - If there is a risk of thunderstorm, Husqvarna recommends that the power supply and all the wires to the charging station are disconnected to decrease the risk of damage to electrical components. Connect the power supply and all the wires again if there is no longer a risk of thunderstorm. It is important that all wires are connected correctly.
 - Follow the maintenance instructions and if necessary use Husqvarna original spare parts, refer to *Maintenance on page 35*.
 - For technical data such as weight, dimensions and noise emission values, refer to *Technical data on page 50*.
 - The operator is responsible for accidents or dangers that occurs to other persons or property.

- The product must only be operated, maintained and repaired by persons that are fully conversant with its special characteristics and safety regulations.
- It is not permitted to change the initial design of the product.
- Obey national regulations about electrical safety.
- Husqvarna does not guarantee full compatibility between the product and other types of wireless systems such as remote controls, radio transmitters or equivalent.
- The built-in alarm is very loud. Be careful, especially if the product is handled indoors.
- Operation and storage temperature range is 0-50 °C / 32-122 °F. Temperature range for charging is 0-45 °C / 32-113 °F. Too high temperatures can cause damage to the product.

2.3 Safety instructions for installation



WARNING: Read the warning instructions that follow before you use the product.

- Do not install the charging station, including any accessory, at a location that is below, or within 60 cm / 24 in. from, any combustible material. In case of malfunction, heating of the charging station and the power supply may occur and create a potential risk of fire.
- Do not put the power supply at a height where there is a risk it can be put in water. Do not put the power supply on the ground.
- Do not encapsulate the power supply. Condensed water can harm the power supply and increase the risk of electrical shock.
- Applicable to USA/Canada. If power supply is installed outdoors: Risk of Electric Shock. Install only to a covered Class A GFCI receptacle (RCD) that has an enclosure that is weatherproof with the attachment plug cap inserted or removed.

2.4 Safety instructions for operation



WARNING: Read the warning instructions that follow before you use the product.

- Keep your hands and feet away from the rotating blades. Do not put your hands or feet near or below the product when it is set to ON.
- Use the park mode or set the product to OFF when persons, especially children or animals are in the work area. Refer to *To switch off the product on page 34*. Husqvarna recommends to set the product to operate when the work area has no activity. The product can cause injury to animals at

night in work area, for example hedgehogs. Refer to *Schedule on page 23*.

- Make sure that there are no objects such as stones, branches, tools or toys on the lawn. The blades can be damaged if it hits an object.
- Do not lift the product or move it when it is set to ON.
- Do not let the product collide with persons or animals. If a person or animal comes in the way of the product, stop the product immediately. Refer to *To stop the product on page 34*.
- Do not put objects on top of the product or its charging station.
- Do not use the product if the **STOP** button does not work.
- Always set the product to OFF when it is not in operation. The product can only start when you enter the correct PIN code.
- Do not use the product at the same time as a pop-up sprinkler. Use the *Schedule* function so the product and pop-up sprinkler do not operate at the same time. Refer to *Schedule on page 23*.

2.5 Safety instructions for maintenance



WARNING: Read the warning instructions that follow before you do maintenance on the product.

- Set the product to **OFF** when you do maintenance on the product.
- Do not use a high-pressure washer to clean the product. Do not use solvents to clean the product.
- Disconnect the plug to the charging station before you clean or do maintenance of the charging station.

2.6 Battery safety



WARNING: Read the warning instructions that follow before you use the product.

- Lithium-ion batteries can explode or cause fire if disassembled, short-circuited, exposed to water, fire, or high temperatures. Handle carefully, do not dismantle, open the battery or use any type of electrical/mechanical abuse. Avoid storage in direct sunlight.

2.7 How to lift and move the product



WARNING: The product must be switched off before lifting it. The product is disabled when the **Main switch** is in position 0.



CAUTION: Do not lift the product when it is parked in the charging station. It can damage the charging station and/or the product. Push **STOP** and pull the product out of the charging station before lifting it.

To safely move from or within the work area:

1. Push the **STOP** button to stop the product.

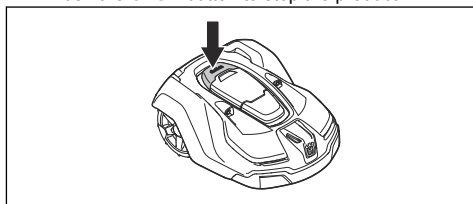

2. Set the main switch in position 0.

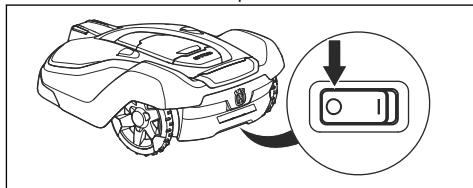

3. Carry the product by the handle with the blade disc away from the body.



3 Installation

3.1 Introduction - Installation



WARNING: Read and understand the safety chapter before you install the product.



CAUTION: Use original spare parts and installation material.

Note: Refer to www.husqvarna.com for more information about installation.

3.2 Main components for installation

The installation involves the following components:

- A robotic lawn mower that mows the lawn automatically.
- A charging station, which has 3 functions:
 - To send control signals along the boundary wire.
 - To send control signals along the guide wire so that the product can follow the guide wire to specific remote areas in the garden and can find its way back to the charging station.
 - To charge the product.
- A power supply, which is connected to the charging station and a 100-240V power outlet.
- Loop wire, which is laid around the work area and around objects and plants that the product must not run into. The loop wire is used both as boundary wire and guide wire.

3.3 General preparations



CAUTION: Holes with water in the lawn can cause damage to the product.

Note: Read through the Installation chapter before beginning the installation. How the installation is done affects how the product performs. It is therefore important to plan the installation carefully.

- Make a blueprint of the work area and include all obstacles. This makes it easier to see the ideal positions for the charging station, the boundary wire and the guide wire.
- Make a mark on the blueprint where to put the charging station, the boundary wire and the guide wire.

- Make a mark on the blueprint where the guide wire connects to the boundary wire. Refer to *To install the guide wire on page 20*.
- Fill in holes in the lawn.
- Cut the grass before you install the product. Make sure that the grass is maximum 10 cm / 3.9 in.

Note: The first weeks after installation the perceived sound level when cutting the grass may be higher than expected. When the product has cut the grass for some time, the perceived sound level is much lower.

3.4 Before the installation of the wires

You can select to attach the wires with stakes or bury them. You can use the 2 procedures for the same work area.



CAUTION: If you use a dethatcher in the work area, bury the boundary wire and the guide wire to prevent them from damage.

3.4.1 To examine where to put the charging station

- Keep a minimum 3 m / 10 ft. of free space in front of the charging station. Refer to *To examine where to put the guide wire on page 18*.
- Keep a minimum of 150 cm / 60 in. of free space to the right and left of the center of the charging station.
- Put the charging station near a power outlet.
- Put the charging station on a level surface.
- The baseplate of the charging station must not be bent.

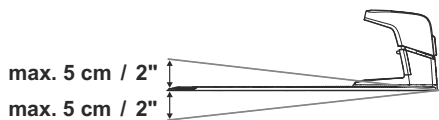

- If the work area has two parts separated with a steep slope, we recommend to put the charging station in the lower section.

- Put the charging station in an area with protection from the sun.
- If the charging station is installed on an island, make sure to connect the guide wire to the island. Refer to *To make an island on page 17*.

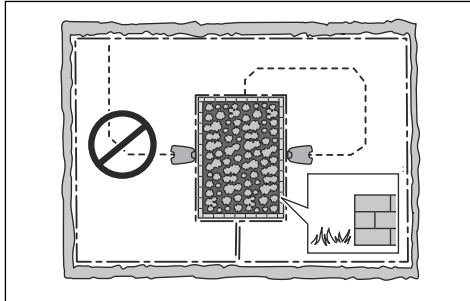

3.4.2 To examine where to put the power supply



WARNING: Do not cut or extend the low-voltage cable. There is a risk of electrical shock.



CAUTION: Make sure that the blades on the product do not cut the low-voltage cable.



WARNING: The power supply cable and extension cable must be outside the work area to avoid damage to the cables.



CAUTION: Do not put the low-voltage cable in a coil or below the charging station plate. The coil causes interference with the signal from the charging station.



- Put the power supply in an area with a roof and protection from the sun and rain.
- Put the power supply in an area with good airflow.
- Use a residual-current device (RCD) with a tripping current of maximum 30 mA when you connect the power supply to the power outlet.

Low-voltage cables of different lengths are available as accessories.

3.4.3 To examine where to put the boundary wire



CAUTION: There must be a barrier of minimum 15 cm / 6 in. in height between the boundary wire and water bodies, slopes, precipices or public roads. This will prevent damage to the product.



CAUTION: Do not let the product operate on gravel.



CAUTION: Do not make sharp bends when you install the boundary wire.



CAUTION: For careful operation without noise, isolate all obstacles such as trees, roots and stones.

The boundary wire should be put as a loop around the work area. Sensors in the product senses when the product approaches the boundary wire, and the product selects another direction. All parts of the work area must be maximum 35 m / 115 ft. from the boundary wire.

To make the connection easier between the guide wire and the boundary wire, it is recommended to make an eyelet where the guide wire will be connected. Make the eyelet with approximately 20 cm / 8 in. of the boundary wire.

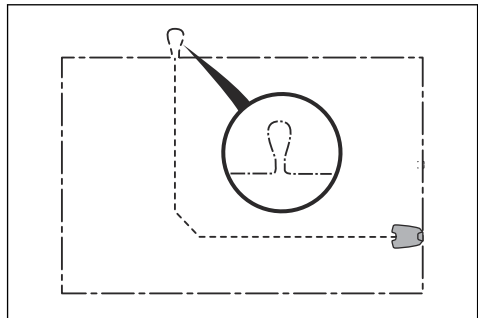

Note: Make a blueprint of the work area before you install the boundary wire and guide wire.

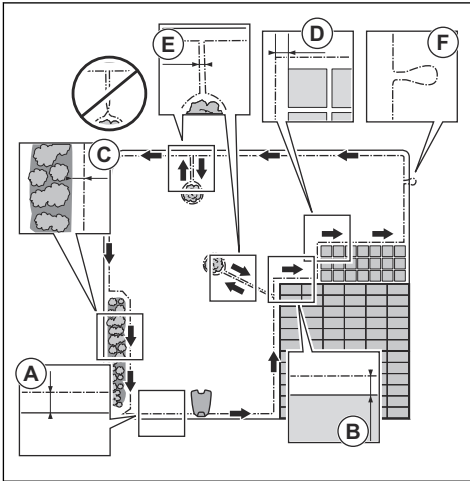

- Put the boundary wire around all of the work area (A). Adapt the distance between the boundary wire and obstacles.
- Put the boundary wire 35 cm / 14 in. (B) from an obstacle that is more than 5 cm / 2 in. high.

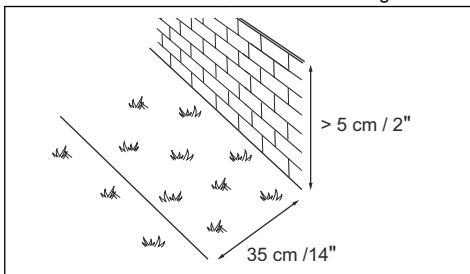

- Put the boundary wire 30 cm / 12 in. (C) from an obstacle that is 1-5 cm / 0.4-2 in. high.

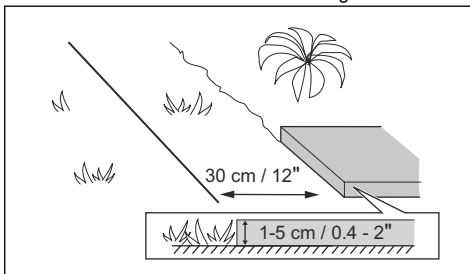

- Put the boundary wire 10 cm / 4 in. (D) from an obstacle that is less than 1 cm / 0.4 in. high.

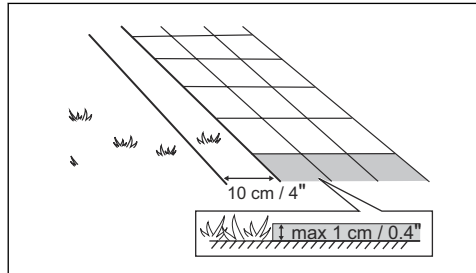

- If you have a paving stone path that is in level with the lawn, put the boundary wire below the paving stone.

Note: If the paving stone is minimum 30 cm / 12 in. wide, use the factory setting for the *Drive Past Wire* function to cut all the grass adjacent to the paving stone. Refer to *To set the Drive Past Wire function* on page 28.

- If you make an island, put the boundary wire that runs to and from the island near together (E). Put the wires in the same stake. Refer to *To make an island* on page 17.
- Make an eyelet (F) where the guide wire is to be connected to the boundary wire.

3.4.3.1 To put the boundary wire in a slope

The product can operate in 45% slopes. Slopes that are too steep must be isolated with the boundary wire. The gradient (%) is calculated as height per m. Example: 10 cm / 100 cm = 10%.

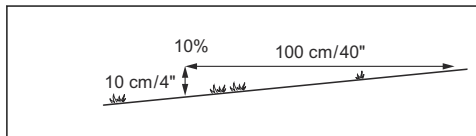

- For slopes steeper than 45% inside the work area, isolate the slope with boundary wire.
- For slopes steeper than 15% along the outer edge of the lawn, put the boundary wire 20 cm / 8 in. (A) from the edge.

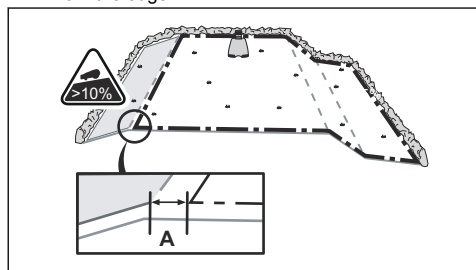

- For slopes adjacent to a public road, put a barrier of minimum 15 cm / 6 in. along the outer edge of

the slope. You can use a wall or a fence as a barrier.

3.4.3.2 Passages

A passage is a section that has boundary wire on each side and that connects 2 parts of the work area. The distance between the boundary wire on each side in the passage must be a minimum of 60 cm / 24 in.

Note: If a passage is less than 2 m / 6.5 ft. wide, install a guide wire through the passage.

The recommended minimum distance between the guide wire and the boundary wire is 30 cm / 12 in. The product always runs to the left of the guide wire as seen facing the charging station. It is recommended to have as much free area as possible to the left of the guide wire (A).

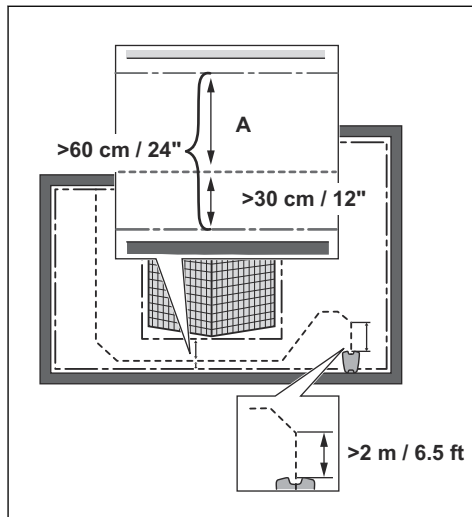

3.4.3.3 To make an island



CAUTION: Do not put a section of boundary wire across the other. The sections of boundary wire must be parallel.



CAUTION: Do not put the guide wire across the boundary wire.



CAUTION: Isolate or remove obstacles that are less than 15 cm / 6 in. in height. Isolate or remove obstacles that slope slightly, for example, stones, trees or roots.

This will prevent damage to the blades of the product.

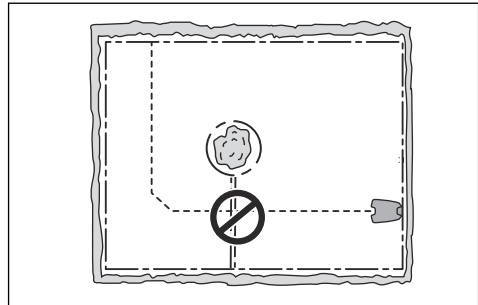

To make an island, isolate areas in the work area with the boundary wire. We recommend to isolate all stable objects in the work area.

Some obstacles are resistant to a collision, for example, trees or bushes that are more than 15 cm / 6 in. in height. The product will collide with the obstacle and then select a new direction.

- Put the boundary wire to and around the obstacle to make an island.
- Put the 2 sections of boundary wire to and from the island close together. This will make the product run across the wire.
- Put the 2 sections of boundary wire in the same stake.

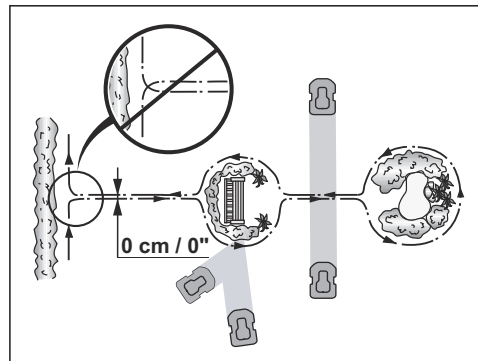

3.4.3.4 To make a secondary area

Make a secondary area (B) if the work area has 2 areas that are not connected with a passage. The work area with the charging station is the main area (A).

Note: The product must be manually moved between the main area and the secondary area.

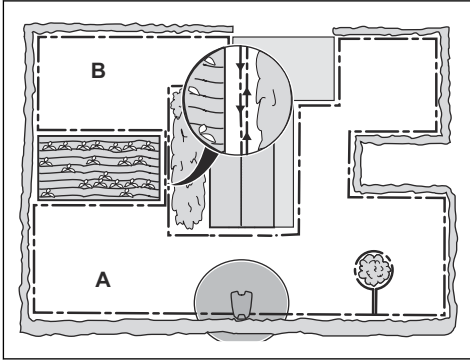

- Put the boundary wire around the secondary area (B) to make an island. Refer to *To make an island on page 17*.

Note: The boundary wire must be put as 1 loop around all of the work area (A + B).

Note: When the product cuts grass in the secondary area, the *Secondary area mode* must be selected. Refer to *Secondary area on page 33*.

3.4.4 To examine where to put the guide wire

- Put the guide wire in a line at a minimum of 2 m / 6.5 ft. in front of the charging station.
- Make as much free area as possible to the left of the guide wire when facing the charging station. Refer to *Corridor width on page 28*.
- Put the guide wire minimum 30 cm / 12 in. from the boundary wire.
- Do not make sharp bends when you install the guide wire.

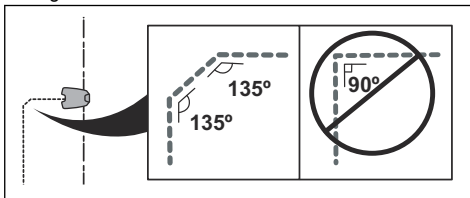

- If the work area has a slope, put the guide wire diagonally across the slope.

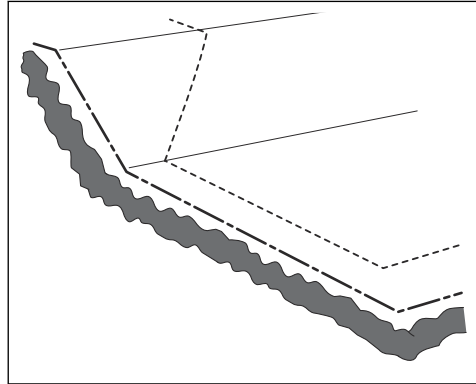

3.4.5 Work area examples

- If the charging station is put in a small area (A), make sure that the distance to the boundary wire is at a minimum 3 m / 10 ft. in front of the charging station.
- If the work area has a passage (B) with no guide wire installed, the recommended minimum distance between the boundary wires is 2 m / 6.5 ft. With a guide wire installed through the passage, the recommended minimum distance between the boundary wires is 60 cm / 24 in.
- If the work area has areas which are connected by a narrow passage (B), you can set the product to first follow and then leave the guide wire after a certain distance (C). The settings can be changed in *Lawn Coverage on page 26*.
- Use the GPS Assisted Navigation that helps the product select the most optimal operation. Refer to *To set the GPS Assisted Navigation on page 26*.
- If the work area includes a secondary area (D), refer to *To make a secondary area on page 17*. Put the product in the secondary area and select *Secondary area mode*.

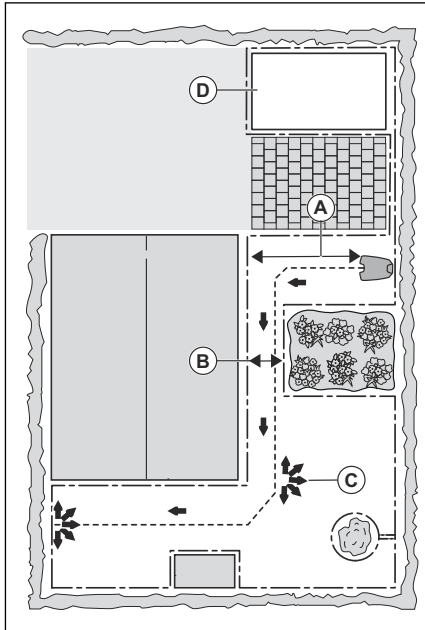

3.5 Installation of the product

3.5.1 Installation tools

- Hammer/plastic mallet: To simplify putting the stakes into the ground.
- Edge cutter/straight spade: To bury the boundary wire.
- Combination pliers: For cutting the boundary wire and pressing the connectors together.
- Adjustable plier: For pressing the couplers together.

3.5.2 To install the charging station



CAUTION: Do not make new holes in the charging station plate.



CAUTION: Do not put your feet on the baseplate of the charging station.



WARNING: Make sure that the plugs of the low-voltage cable and the power supply unit are clean and dry before you connect them.

When connecting the power supply, only use a power outlet that is connected to an residual-current (RCD) device.

1. Read and understand the instructions about the charging station. Refer to *To examine where to put the charging station on page 14*.
2. Put the charging station in the selected area.

Note: Do not attach the charging station to the ground with the screws until the guide wire is installed. Refer to *To install the guide wire on page 20*.

3. Connect the low-voltage cable to the charging station.
4. Put the power supply at a minimum height of 30 cm / 12 in.

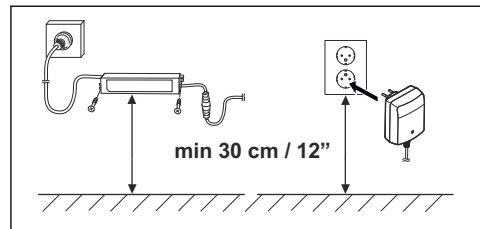

5. Connect the power supply cable to a 100-240V power outlet.

Note: When the charging station is connected, it is possible to charge the product. Place the product in the charging station while the boundary and guide wires are being laid. Switch on the product. Do not continue with any product settings before the installation is complete.

6. Put the low-voltage cable in the ground with stakes or bury the cable. Refer to *To put the wire into position with stakes on page 20* or *To bury the boundary wire or the guide wire on page 21*.
7. Connect the wires to the charging station after the installation of boundary wire and guide wire is complete. Refer to *To install the boundary wire on page 19* and *To install the boundary wire on page 19*.
8. Attach the charging station to the ground with the supplied screws after the guide wire is installed. Refer to *To install the guide wire on page 20*.

3.5.3 To install the boundary wire



CAUTION: Do not put remaining wire in a coil. The coil causes interference with the product.

- Put the boundary wire around all of the work area. Start and complete the installation behind the charging station.
- Open the connector and put the boundary wire in the connector.

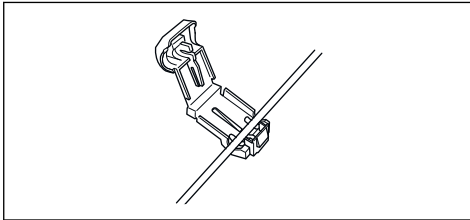

- Close the connector with a pair of pliers.

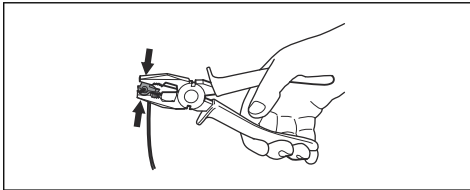

- Cut the boundary wire 1-2 cm / 0.4-0.8 in. above each connector.
- Push the right connector onto the metal pin on the charging station with the mark "AR".
- Push the left connector onto the metal pin on the charging station with the mark "AL".

3.5.4 To install the guide wire



CAUTION: Twinned cables, or a screw terminal block that is insulated with insulation tape are not satisfactory splices. Soil moisture will cause the wire to oxidize and after a time result in a broken circuit.

- Open the connector and put the wires in the connector.
- Close the connector with a pair of pliers.
- Cut the guide wires 1-2 cm / 0.4-0.8 in. above each connector.
- Put the guide wires centrally below the charging station plate, and push them through the slot in the charging station tower.
- Push the connector onto the metal pin on the charging station with the mark "G1, G2" or "G3".
- Disconnect the charging station from the power outlet.
- Put the cable mark on the guide wires.
- Put the end of the guide wires at the eyelet on the boundary wire.
- Cut the boundary wire with a pair of wire cutters.

- Connect the guide wires to the boundary wire with a coupler.

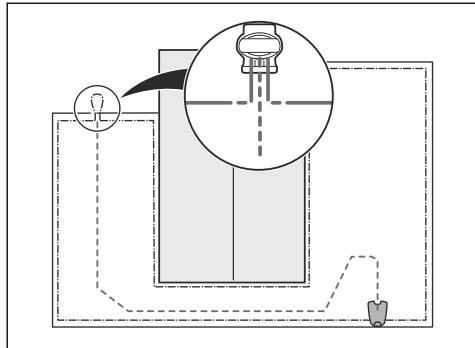

- Put the 2 ends of the boundary wire and the end of the guide wires into the coupler.

Note: Make sure that you can see the end of the guide wires through the transparent area of the coupler.

- Push down the cover on the coupler with adjustable pliers to attach the wires in the coupler.

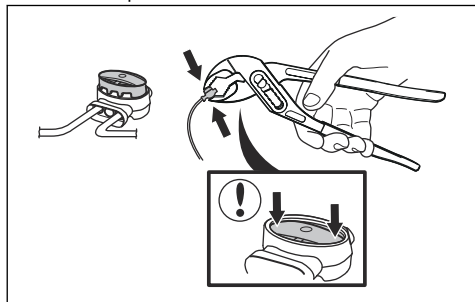

- Attach the guide wires to the ground with stakes or bury the guide wires in the ground. Refer to *To put the wire into position with stakes on page 20* or *To bury the boundary wire or the guide wire on page 21*.
- Connect the charging station to the power outlet.

3.6 To put the wire into position with stakes



CAUTION: Make sure that the stakes hold the boundary wire and the guide wire against the ground.



CAUTION: Cutting the grass too low right after installation can damage the wire insulation. Damage to the insulation may not cause disruptions until several weeks or months later.

1. Put the boundary wire and the guide wire on the ground.
2. Put the stakes at a maximum of 75 cm / 30 in. distance from each other.
3. Attach the stakes to the ground with a hammer or a plastic mallet.

Note: The wire is overgrown with grass and not visible after a few weeks.

3.7 To bury the boundary wire or the guide wire

- Cut a groove in the ground with an edge cutter or a straight shovel.
- Put the boundary wire or the guide wire 1-20 cm / 0.4-8 in. into the ground.

3.8 To extend the boundary wire or the guide wire

Note: Extend the boundary wire or the guide wire if it is too short for the work area. Use original spare parts, for example couplers.

1. Disconnect the charging station from the power outlet.
2. Cut the boundary wire or the guide wire with a pair of wire cutters where it is necessary to install the extension.
3. Add wire where it is necessary to install the extension.
4. Put the boundary wire or the guide wire into position.
5. Put the wire ends into a coupler.

Note: Make sure that you can see the ends of the boundary wire or the guide wire through the transparent area of the coupler.

6. Push down the cover on the coupler with adjustable pliers to attach the wires in the coupler.

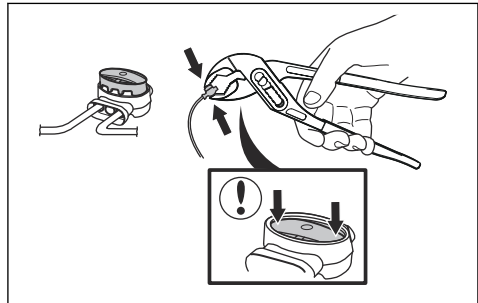

7. Put the boundary wire or the guide wire into position with stakes.
8. Connect the charging station to the power outlet.

3.9 After the installation of the product

3.9.1 To do a visual check of the charging station

1. Make sure that the indicator LED lamp on the charging station has a green light.

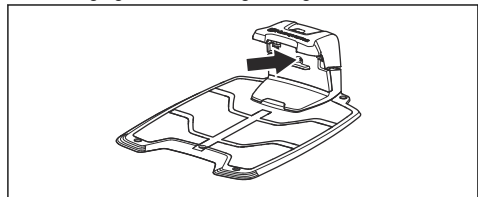

2. If the indicator LED lamp does not have a green light, do a check of the installation. Refer to *To install the charging station on page 19* and *Indicator lamp in the charging station on page 44*.

3.9.2 To do the basic settings

Before the product starts to operate for the first time, you must do the basic settings.

1. Put the product in the charging station.
2. Switch on the product.
3. Push the **arrow** buttons and the **OK** button. Select language, country, date, time and set a PIN code.

Note: For some models, a factory PIN code is necessary before you select a personal PIN code. It is not possible to use 0000 as PIN code.

4. Push the **Start** button and close the hatch to initiate a calibration process of the product.

Note: If the battery is too low, the product needs to charge the batteries fully before the calibration starts. Refer to *Calibration on page 22*.

Note: Make a note of the PIN code. Refer to *Introduction on page 3*.

3.9.3 Calibration

The calibration process is automatic. After the basic settings are done, the product moves away from the charging station and stops, while it calibrates some of the product settings. When the calibration is complete, the product starts to mow.

3.10 Product settings

You can use the keypad and the display on the product or the Automower® Connect app to do the settings for the functions of the product. The functions of the product have factory settings that are applicable for almost all work areas, but the settings can be adapted to the conditions for each work area.

3.11 Automower® Connect app

The product can connect to mobile devices that have the Automower® Connect app installed. Automower® Connect is a free app for your mobile device. You can use the extended functions for the product in the Automower® Connect app.

- The *Dashboard* shows the current operation of the product. You can select an operating mode for the product in the dashboard.
- The *Map* shows the current position of the product and the set center point for the GeoFence function.
- In the *Settings* menu you can set the settings for the product.
- In the *Statistics* menu you can see the statistics of the product.
- In the *Messages* menu you can find the *Fault messages* and the *Information messages* of the product.



The Automower® Connect app has Long-range cellular connectivity and Short-range Bluetooth® connectivity.

3.11.1 To install the Automower® Connect app

1. Download the Automower® Connect app on your mobile device.
2. Sign up for a Husqvarna account in the Automower® Connect app.
3. An e-mail is sent to the registered e-mail address. Follow the instructions in the e-mail in less than 24 hours to validate your account.
4. Log in to your Husqvarna account in the Automower® Connect app.

3.11.2 To pair Automower® Connect and the product

Bluetooth® communication and the Automower® Connect kit for cellular communication are included in Automower® 430X/450X.

1. Do steps 1–3 in *To get access to the menu in the display of the product on page 22*.
2. Use the **arrow** buttons and the **OK** button to move through the menu structure *Accessories > Automower® Connect > Pairing > New pairing*.
3. Follow the instructions in the Automower® Connect app.

3.11.3 To pair Automower® Connect@Home and the product

Automower® Connect@Home function with Bluetooth® communication is included in Automower® 420/440. This means that the mobile device can communicate with the product while you are in Bluetooth® communication range.

1. Do steps 1–3 in *To get access to the menu in the display of the product on page 22*.
2. Use the **arrow** buttons and the **OK** button to move through the menu structure *Accessories > Connect@Home > Pairing > New pairing*.
3. Follow the instructions in the Automower® Connect app.

3.12 Product settings with keypad and display

3.12.1 To get access to the menu in the display of the product

1. Push the **STOP** button.
2. Use the **number** buttons and the **OK** button to enter the PIN code.
3. Push the **MENU** button.

3.12.2 Menu structure

The main menu contains:

- *Schedule*

- *Cutting height*
- *Security*
- *Messages*
- *Weather timer*
- *Installation*
- *Settings*
- *Accessories*

Refer to *Menu structure overview 1 on page 7*, *Menu structure overview 2 on page 8* and *Menu structure overview 3 on page 9*.

3.12.3 Schedule



Note: The lawn should not be cut too often to obtain the best result. If the product is allowed to operate too much, the lawn may appear flattened. The product is also subjected to unnecessary wear.

3.12.3.1 To set the schedule

1. Do steps 1–3 in *To get access to the menu in the display of the product on page 22*.
2. Use the **arrow** buttons and the **OK** button to move through the menu structure *Schedule > Overview*.
3. Use the **arrow** buttons and the **OK** button to select the day.
4. Use the right **arrow** button to select the period.
5. Push the **OK** button.
6. Calculate the suitable operating hours. Refer to *To calculate the suitable operating hours on page 23*.
7. Enter the time with the **number** buttons. The product can cut the grass 1 or 2 periods each day.

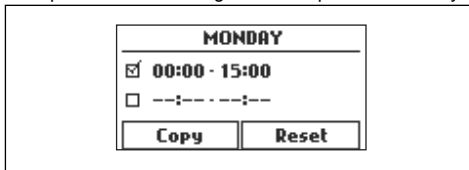

8. If the product must not cut grass on a specified day, unselect the box adjacent to the 2 time periods.

3.12.3.2 To calculate the suitable operating hours

If the work area is less than maximum product capacity, the schedule should be set to minimize wear on the lawn and the product.

1. Calculate the dimension of your lawn in m^2 / ft^2 .
2. Divide the m^2 / ft^2 of the lawn with the approximate daily operation capacity. Refer to table below.

3. The result is equal to the number of hours that the product must mow each day. The number of hours includes both mowing, searching and charging time.

Product work capacity	Approximate daily operation capacity, m^2/h , ft^2/h
Automower® 420	92 / 990
Automower® 430X	133 / 1430
Automower® 440	167 / 1800
Automower® 450X	208 / 2240

Example: A lawn of $500 m^2 / 5400 ft^2$, cut with a Automower® 420.

$500 m^2 / 92 \approx 5.5 h$.

$5400 ft^2 / 990 \approx 5.5 h$.

Days / week	h / day	Suggested schedule setting
7	5.5	07:00- 12:30 / 7:00 am - 12:30 pm

3.12.3.3 To copy the schedule setting

1. Do steps 1–3 in *To get access to the menu in the display of the product on page 22*.
2. Use the **arrow** buttons and the **OK** button to move through the menu structure *Schedule > Overview > Copy*.
3. Use the **arrow** buttons and the **OK** button to copy the schedule setting. You can copy the schedule settings day to day or for the full week.

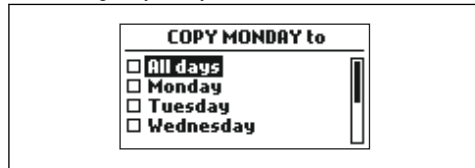

3.12.3.4 To reset the schedule setting

You can remove all schedule settings and use the factory setting.

1. Do steps 1–3 in *To get access to the menu in the display of the product on page 22*.
2. Use the **arrow** buttons and the **OK** button to move through the menu structure *Schedule > Overview > Reset*.
 - a) Push the **arrow** buttons to select *Current day* to only reset the current day to factory settings.
 - b) Push the **arrow** buttons to select *All week* to reset all schedule settings to factory settings.
3. Push the **OK** button.

3.12.4 Cutting height



3.12.4.1 Adjust the cutting height



CAUTION: During the first weeks after a new installation, the cutting height must be set to MAX to avoid damaging the loop wire. After this, the cutting height can be lowered step by step every week until the desired cutting height has been reached.

The cutting height can be varied from MIN (2 cm / 0.8 in.) to MAX (6 cm / 2.4 in.).

To set the cutting height

1. Do steps 1–3 in *To get access to the menu in the display of the product on page 22*.
2. Use the **arrow** buttons and the **OK** button to move through the menu structure *Cutting height > Cutting height*.
3. Use the **arrow** buttons to set the cutting height.
4. Push the **OK** button.

3.12.4.2 TargetHeight

Use the TargetHeight function to lower the cutting height from MAX to the specified cutting height gradually during 10 days. If you change the cutting height manually during this time it will disable the TargetHeight function.

To set the TargetHeight

1. Do steps 1–3 in *To get access to the menu in the display of the product on page 22*.
2. Use the arrow buttons and the **OK** button to move through the menu structure *Cutting height > TargetHeight*.
3. Push the **OK** button to enable or disable the function.
4. Push the **BACK** button.

3.12.5 Security level



There are 3 security levels for the product.

Function	Low	Medium	High
<i>Alarm</i>			X
<i>PIN-code</i>		X	X
<i>Time lock</i>	X	X	X

- *Alarm* - An alarm goes off if the PIN-code is not entered within 10 seconds after the **STOP** button is pushed. The alarm also goes off when the product is lifted. The alarm stops when the PIN-code is entered.
- *PIN-code* - The correct PIN-code must be entered to get access to the Menu structure of the product. If the incorrect PIN-code is entered 5 times, the product is locked for a time. The lock is extended for each new incorrect try.
- *Time lock* - The product locks if the PIN-code has not been entered in 30 days. Enter the PIN-code to get access to the product.

3.12.5.1 To set the security level

Select 1 of 3 security levels for your product.

1. Do steps 1–3 in *To get access to the menu in the display of the product on page 22*.
2. Use the **arrow** buttons and the **OK** button to move through the menu structure *Settings > Security > Security level*.
3. Use the **arrow** buttons and the **OK** button to select the level of security.
4. Push the **OK** button.

3.12.5.2 To create a New loop signal

The loop signal is randomly selected to create a unique link between the product and the charging station. In rare cases, there may be a need to generate a new signal, for instance if two adjacent installations have a very similar signal.

1. Place the product in the charging station.
2. Do steps 1–3 in *To get access to the menu in the display of the product on page 22*.
3. Use the **arrow** buttons and the **OK** button to move through the menu structure *Security > Advanced > New loop signal*.
4. Await confirmation that the loop signal has been generated. This normally takes about 10 seconds.

3.12.5.3 To change the PIN-code

1. Do steps 1–3 in *To get access to the menu in the display of the product on page 22*.
2. Use the **arrow** buttons and the **OK** button to move through the menu structure *Settings > Security > Advanced > Change PIN-code*.
3. Enter the new PIN code.
4. Push the **OK** button.
5. Enter the new PIN code again.
6. Push the **OK** button.
7. Make a note of the new PIN code. Refer to *Introduction on page 3*.

3.12.5.4 To change the duration of the alarm

1. Do steps 1–3 in *To get access to the menu in the display of the product on page 22*.

2. Use the **arrow buttons** and the **OK** button to move through the menu structure *Security > Advanced > Duration > Duration of alarm*.
3. Use the **arrow buttons** to select a time interval of 1 to 20 minutes.
4. Push the **BACK** button.

3.12.5.5 To change the duration of the time lock

1. Do steps 1–3 in *To get access to the menu in the display of the product on page 22*.
2. Use the **arrow buttons** and the **OK** button to move through the menu structure *Security > Advanced > Duration > Duration of time lock*.
3. Use the **number buttons** to select a time interval of 1–90 days.
4. Push the **BACK** button.

3.12.6 Messages



In this menu the previous fault and information messages can be found. For some of the messages, there are tips and advice to help to rectify the fault. Refer to *Troubleshooting on page 37*.

If the product is disrupted in any way, for example it is trapped or the battery is low, a message is saved relating to the disruption and the time it happened.

If the same message is repeated several times, this may indicate that an adjustment to the installation or the product is required. Refer to *Installation on page 14*.

3.12.6.1 To read the messages

1. Do steps 1–3 in *To get access to the menu in the display of the product on page 22*.
2. Use the **arrow** buttons and the **OK** button to move through the menu structure *Messages > Fault messages* and *Messages > Info messages*.
3. Read the messages and read the *Troubleshooting* to get information and recommendations to correct the faults.

3.12.7 Weather timer



Weather timer automatically adjust the cutting time to the growth of the grass. The product is not permitted to operate more than the schedule settings.

Note: When using *Weather timer*, it is recommended to make as much operating time as possible available

for *Weather timer*. Do not restrict the schedule more than necessary.

The first operation of the day is set by the schedule settings. The product always complete 1 mowing cycle, and then *Weather timer* selects if the product will continue to operate or not.

Note: *Weather timer* is reset if the product does not operate for more than 50 hours, or if a *Reset of all user settings* is done. *Weather timer* is not changed if a *Reset of schedule settings* is done.

3.12.7.1 To set the Weather timer

1. Do steps 1–3 in *To get access to the menu in the display of the product on page 22*.
2. Use the **arrow** buttons and the **OK** button to move through the menu structure *Weather timer > Use Weather timer*.
3. Push the **OK** button to select the *Weather timer*.
4. Push the **BACK** button.

3.12.7.2 To set the Weather timer frequency

Set how frequently the product cuts the grass when the *Weather timer* is in use. There are 3 frequency levels: *Low*, *Mid* and *High*. The higher the frequency, the more sensitive the product is to the grass growth. That is, if the grass growth is high then the product is allowed to work longer.

Note: If the mowing results are not optimal when using *Weather timer*, the schedule settings may need adjusting. Do not restrict the schedule more than necessary. Also, check that the blade disc is clean and that the blades are in good condition.

1. Do steps 1–3 in *To get access to the menu in the display of the product on page 22*.
2. Use the **arrow** buttons and the **OK** button to move through the menu structure *Weather timer > Cutting time*.
3. Use the **arrow** buttons to select *Low*, *Mid* or *High* frequency.
4. Push the **BACK** button.

3.12.8 Installation



In the Installation menu it is possible to adapt the settings of the product for best mowing result.

3.12.8.1 Lawn Coverage

If the work area includes remote parts that are connected with narrow passages, the *Lawn Coverage* function is useful to be able to maintain a well-cut lawn in all parts of the yard. A guide wire must be installed to use the functions. You can set a maximum of 5 remote areas.

With the *Lawn Coverage* function the product first follows and then leaves the guide wire after a certain distance and starts to mow the lawn.

Area A, approximately 50%

Area B, approximately 30%

Area C, approximately 20%

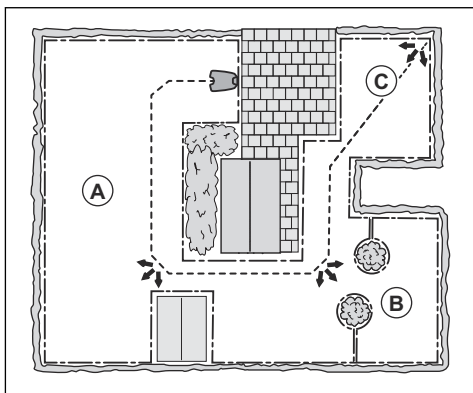

GPS Assisted Navigation

Only for Automower® 430XI/450X.

The GPS Assisted Navigation function helps the product to select the most optimal operation. Use the *Lawn coverage* function to do manual settings.

To set the GPS Assisted Navigation

Disable the GPS Assisted Navigation to make manual settings in *Lawn coverage*.

Note: It is recommended to use GPS Assisted Navigation.

1. Do steps 1–3 in *To get access to the menu in the display of the product on page 22*.
2. Use the **arrow** buttons and the **OK** button to move through the menu structure *Installation > Lawn coverage*.
3. Push the **OK** button to enable or disable the function.
4. Push the **BACK** button.

To set the Lawn Coverage function

1. Do steps 1–3 in *To get access to the menu in the display of the product on page 22*.

2. Use the **arrow** buttons and the **OK** button to move through the menu structure *Installation > Lawn Coverage > Area 1-5*.
3. Use the **arrow** button to select the area.
4. Push the **OK** button.
5. Measure the distance from the charging station to the start of the area. Measure along the guide wire. Refer to *To measure the distance from the charging station on page 26*.
6. Push the **number** buttons to select the distance.
7. Push the **OK** button.
8. Use the **number** buttons to select the percentage of the cutting time the product must cut the area. The percentage is equal to the area in relation to the complete work area.
 - a) Measure the area.
 - b) Divide the measured area with the total work area.
 - c) Convert the result to percentage.

Note: The sum of Area 1-5 must be 100% or less. If the sum is less than 100%, the product sometimes starts to mow at the charging station. Refer to *To set the exit angle on page 28*.

9. Push the **BACK** button.

To do a test of the Lawn Coverage function

1. Put the product in the charging station.
2. Do step 1-3 in *To get access to the menu in the display of the product on page 22*.
3. Use the **arrow** buttons and the **OK** button to move through the menu structure *Installation > Lawn Coverage > Area 1-5 > More > Test*.
4. Push the **OK** button.
5. Push the **START** button.
6. Close the hatch.
7. Make sure the product can find the area.

To measure the distance from the charging station

1. Put the product in the charging station.
2. Do steps 1–3 in *To get access to the menu in the display of the product on page 22*.
3. Use the **arrow** buttons and the **OK** button to move through the menu structure *Installation > Lawn Coverage > Area 1-5 > How far?*
4. Use the **number** buttons to set 500 m / 500 yd as a distance.
5. Push the **OK** button.
6. Use the **arrow** buttons and the **OK** button to move through the menu structure *Settings > Lawn Coverage > Area 1-5 > More > Test*.
7. Push the **OK** button.

8. Push the **STOP** button when the product is at the distance you select to measure. The distance shows in the display.

To disable or enable the Lawn Coverage function

Disable or enable the *Lawn Coverage* function for each area.

1. Do steps 1–3 in *To get access to the menu in the display of the product on page 22*.
2. Use the **arrow** buttons and the **OK** button to move through the menu structure *Installation > Lawn Coverage > Area 1-5 > Disable*.
3. Push the **OK** button.
4. Push the **BACK** button.

To reset the Lawn Coverage settings

You can reset the *Lawn Coverage* settings for each area and use the factory setting.

1. Do steps 1–3 in *To get access to the menu in the display of the product on page 22*.
2. Use the **arrow** buttons and the **OK** button to move through the menu structure *Installation > Lawn Coverage > Area 1-5 > More > Reset*.
3. Push the **OK** button.

3.12.8.2 Methods for the product to find the charging station

The product has 3 search methods to find the charging station:

- Irregular - The product operates in the work area until it finds the signal of the charging station.
- Guide wire - The product operates in the work area until it finds the signal of the charging station or the guide wire. If it finds the guide wire the product moves along the guide wire to the charging station.
- Boundary wire - The product moves in the work area until it finds the signal of the charging station, the guide wire or the boundary wire. If it finds the boundary wire, the product moves along the boundary wire to the charging station.

The factory setting is set to mix the 3 search methods. When the battery is low the product starts to search for the charging station with the irregular method for 3 min. After 3 min the product changes search method to the guide wire method. After 11 min the product changes search method to the boundary wire method.

You can change the settings for how the product finds the charging station to adapt to the work area.

To set how the product finds the charging station

You can make manual settings to make the product search for the guide wire or the boundary wire in 0–30 min from when the battery is low.

1. Do steps 1–3 in *To get access to the menu in the display of the product on page 22*.
2. Use the **arrow** buttons and the **OK** button to move through the menu structure *Installation > To find*

the charging station > Overview of search methods > Guide.

3. Push the **arrow** buttons to select 1 of the guide wires.
4. Push the **number** buttons to set the time.
5. Push the **OK** button.
6. Push the **BACK** button.
7. Use the **arrow** buttons and the **OK** button to move through the menu structure *Installation > To find the charging station > Overview of search methods > Boundary wire*.
8. Push the **number** buttons to set the time.
9. Push the **OK** button.
10. Push the **START** button and close the hatch.

To do a test of the guide wire

1. Do steps 1–3 in *To get access to the menu in the display of the product on page 22*.
2. Use the **arrow** buttons and the **OK** button to move through the menu structure *Installation > Find charging station > Guide > More > Test guide*.
3. Put the product 3 m / 9 ft. from the guide wire, facing the guide wire.
4. Push the **START** button and close the hatch.
5. Make sure the product follows the guide wire to the charging station.
6. Make sure the product docks with the charging station.
7. If the product does not dock with the charging station, change the position of the charging station or the guide wire. Refer to *To install the charging station on page 19* and *To install the guide wire on page 20*.

To do a test of the boundary wire

1. Put the product 3 m / 9 ft. from the boundary wire, facing the boundary wire.
2. Do steps 1–3 in *To get access to the menu in the display of the product on page 22*.
3. Use the **arrow** buttons and the **OK** button to move through the menu structure *Installation > Find charging station > Overview of search methods > Boundary > More > Test right / Test left*.
4. Push the **START** button and close the hatch.
5. Make sure the product follows the boundary wire to the charging station.
6. Make sure the product docks with the charging station.
7. Change the position of the charging station or the boundary wire if the product does not dock with the charging station. Refer to *To install the charging station on page 19* and *To install the guide wire on page 20*.

To change the signal range of the charging station

1. Do steps 1–3 in *To get access to the menu in the display of the product on page 22*.
2. Use the **arrow buttons** and the **OK** button to move through the menu structure *Installation > Find the charging station > Overview of search methods > Charging station range*.
3. Use the left **arrow button** to select *MAX, MID, MIN*.
4. Push the **BACK** button.

Note: It is usually better to move the charging station, than to decrease the range of the charging station signal.

3.12.8.3 Corridor width

The boundary wire corridor is the area adjacent to the boundary wire and the guide corridor is the area adjacent to the guide wire. The product uses the corridors to find the charging station. When the product moves in the direction of the charging station, it always moves to the left of the guide wire.

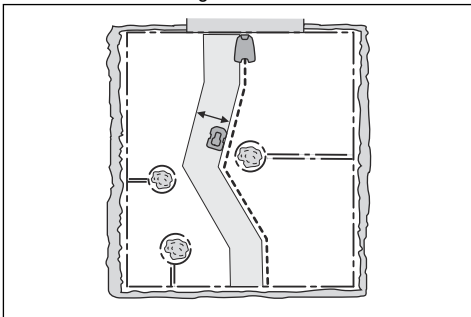

The corridor width is adjusted automatically. If it is necessary to adjust the corridor width manually for the product to operate satisfactorily, you can set the corridor width between 0-9. If guide corridor width is set to 0, the product straddles the guide wire. The factory setting is 6 for the boundary wire and 9 for the guide wire.

To set the corridor width

1. Do steps 1–3 in *To get access to the menu in the display of the product on page 22*.
2. Use the **arrow buttons** and the **OK** button to move through the menu structure *Installation > Advanced > Corridor width*.
3. Use the **arrow** buttons to select a corridor.
4. Use the **number** buttons to select a corridor width of 0-9.

Note: Make the corridor width as wide as possible for a minimum risk of lines in the lawn.

3.12.8.4 Exit angle

If the sum of the *Lawn Coverage* function is less than 100%, the product sometimes starts to mow at the charging station. The product moves away from the charging station with an exit angle between 90°–270°. The exit angles can be set to 1–2 exit sectors.

To set the exit angle

1. Do steps 1–3 in *To get access to the menu in the display of the product on page 22*.
2. Use the **arrow** buttons and the **OK** button to move through the menu structure *Installation > Advanced > Exit angles > Sector 1*.
3. Use the **number** buttons to set the angles in degrees.
4. Push the down **arrow** button.
5. Use the **number** buttons to select how frequently the product must use each sector. Set in percentage.
6. Push the **BACK** button.

3.12.8.5 Reversing distance

The reversing distance makes the product move in reverse for a set distance, before the product starts to cut the lawn. The factory setting is 60 cm / 2 ft.

To set the reversing distance

1. Do steps 1-3 in *To get access to the menu in the display of the product on page 22*.
2. Use the **arrow** button and the **OK** button to move through the menu structure *Installation > Advanced > Reversing distance*.
3. Use the **number** buttons to set the distance.
4. Push the **BACK** button.

3.12.8.6 Drive Past Wire function

The front of the product always moves past the boundary wire by a specified distance. Then the product moves rearward and changes direction. The factory setting is 31 cm / 13 in. You can select a distance of 20-50 cm / 10-15 in.

Note: If you change the distance for *Drive Past Wire*, the distance will change along the boundary wire in all parts of the work area.

To set the Drive Past Wire function

1. Do steps 1–3 in *To get access to the menu in the display of the product on page 22*.
2. Use the **arrow** button and the **OK** button to move through the menu structure *Installation > Advanced > Drive Past Wire*.
3. Use the **number** buttons to set the distance.
4. Push the **BACK** button.

3.12.9 Settings



In settings you can change the general settings to your product.

3.12.9.1 Profiles

With the function Profiles, different sets of product settings can be saved. This can be used when one product is used for more than one work areas and charging stations. The product settings and the pairing with the charging stations are saved in the profile and can easily be used again.

To save settings to a profile

1. Do steps 1–3 in *To get access to the menu in the display of the product on page 22*.
2. Use the **arrow buttons** and the **OK** button to move through the menu structure *Settings > Profiles > Use profiles > Profile A, B, C*.
3. Use the **arrow buttons** and the **OK** button to select and save the profile.
4. Push the **BACK** button.

If settings have been changed but not saved, the symbol * is shown beside the profile name.

To change the name of a profile

1. Do steps 1–3 in *To get access to the menu in the display of the product on page 22*.
2. Use the **arrow buttons** and the **OK** button to move through the menu structure *Settings > Profiles > Use profiles > Profile A, B, C > Rename*.
3. Use the **arrow buttons** and the **OK** button to select letters.
4. Push the **BACK** button to save the new profile name.

To use a profile

1. Do steps 1–3 in *To get access to the menu in the display of the product on page 22*.
2. Use the **arrow buttons** and the **OK** button to move through the menu structure *Settings > Profiles > Use profiles > Profile A, B, C > Select*.
3. Push the **BACK** button.

To connect a new charging station to a profile

1. Save the settings in a profile to be used with the original charging station. Do steps 1–4 in *To save settings to a profile on page 29*.
2. Put the product in the new charging station.
3. Use the **arrow buttons** and the **OK** button to move through the menu structure *Security > Advanced > New loop signal*.

4. Save a profile for the new charging station, or select a profile in the list. Do steps 1–4 in *To save settings to a profile on page 29*, or do steps 1–3 in *To use a profile on page 29*.

3.12.9.2 ECO mode

If *ECO mode* is activated, it switches off the signal in the boundary loop, the guide wire and the charging station, when the product is parked or is charging.

Note: Use *ECO mode* to save energy and avoid interference with other equipment, for example hearing loops or garage doors.

Note: To start the product manually in the work area, push the **STOP** button before you remove the product from the charging station. If not, the product cannot be started in the work area.

To set the ECO mode

1. Do steps 1–3 in *To get access to the menu in the display of the product on page 22*.
2. Use the **arrow** buttons and the **OK** button to move through the menu structure *Settings > ECO mode*.
3. Push the **OK** button to select the *ECO mode*.
4. Push the **BACK** button.

3.12.9.3 Spiral Cutting

The product cuts the grass in a spiral pattern if the grass is longer in an area. *Spiral cutting* can be set in 5 levels:

- Low-
- Low
- Mid
- High
- High+

The level sets how sensitive the product is to changes in grass height.

Note: *Spiral cutting* is only started in the Main area mode. Cutting in the *Secondary area* mode does not let the product to start *Spiral cutting*. *Spiral Cutting* does not start in slopes steeper than 15%.

To set the Spiral Cutting

1. Do steps 1–3 in *To get access to the menu in the display of the product on page 22*.
2. Use the **arrow buttons** and the **OK** button to move through the menu structure *Settings > Spiral Cutting > Use Spiral Cutting*.
3. Push the **BACK** button.

To set the level of Spiral Cutting

1. Do steps 1–3 in *To get access to the menu in the display of the product on page 22*.

2. Use the **arrow buttons** and the **OK** button to move through the menu structure *Settings > Spiral Cutting > Use Spiral Cutting > Intensity*.
3. Use the left **arrow button** to select the level of the Spiral Cutting.
4. Push the **BACK** button.

3.12.9.4 Slope control

In order to decrease lawn wear near the boundary wire in slopes, the product prevents to move in the opposite direction when the product operates in a slope. *Slope control* is enabled in the factory settings.

To set the Slope control

1. Do steps 1–3 in *To get access to the menu in the display of the product on page 22*.
2. Use the **arrow buttons** and the **OK** button to move through the menu structure *Settings > Slope control > Use Slope control*.
3. Push the **BACK** button.

3.12.9.5 General

In *General* you can change the general settings of the product.

To set the time & date

1. Do steps 1–3 in *To get access to the menu in the display of the product on page 22*.
2. Use the **arrow buttons** and the **OK** button to move through the menu structure *Settings > General > Time & Date*.
3. Use the **number buttons** to set the time and then push the **BACK** button.
4. Use the **number buttons** to set the date and then push the **BACK** button.
5. Use the **arrow buttons** to set the time format and then push the **BACK** button.
6. Use the **arrow buttons** to set the date format and then push the **BACK** button.

To set the language

1. Do steps 1–3 in *To get access to the menu in the display of the product on page 22*.
2. Use the **arrow buttons** and the **OK** button to move through the menu structure *Settings > General > Language*.
3. Use the **arrow buttons** to select language and then push the **BACK** button.

To set the Country & Timezone

1. Do steps 1–3 in *To get access to the menu in the display of the product on page 22*.
2. Use the **arrow buttons** and the **OK** button to move through the menu structure *Settings > General > Country & Timezone*.
3. Use the **arrow buttons** to select country and then push the **BACK** button.

To set the unit format

1. Do steps 1–3 in *To get access to the menu in the display of the product on page 22*.
2. Use the **arrow buttons** and the **OK** button to move through the menu structure *Settings > General > Unit format*.
3. Use the **arrow buttons** to select unit format and then push the **BACK** button.

To reset all user settings

1. Do steps 1–3 in *To get access to the menu in the display of the product on page 22*.
2. Use the **arrow buttons** and the **OK** button to move through the menu structure *Settings > General > Reset all user settings*.
3. Use the right **arrow button** to select *Proceed with reset of all user settings?*
4. Push the **OK** button to reset all the user settings.

Note: *Security level, PIN code, Loop signal, Messages, Date & Time, Language and Country settings* are not reset.

The About menu

The *About* menu displays information about the product, for example serial number and firmware versions.

3.12.10 Accessories



Settings for accessories mounted on the product can be made in this menu.

3.12.10.1 Information

This menu handles accessories mounted on the product. Contact your local Husqvarna representative for more information on available accessories.

3.12.10.2 Automower® Connect

The product can connect to mobile devices that have the Automower® Connect app installed. The Automower® Connect app has Long-range cellular connectivity and Short-range Bluetooth® connectivity. Refer to *Automower® Connect app on page 22*.

Note: Automower® Connect is always connected to your product while the mobile device have connection with the mobile network and the product is switched on.

Note: All countries do not support Automower® Connect because of regional specified cellular systems. The included Automower® Connect life-time service only applies if there is a third part sub-supplier of 2G/3G/4G available in the operational area. In some countries Bluetooth® is not available because of legal reasons.

To enable the GeoFence function

GeoFence is a GPS-based theft protection that makes a virtual fence for the product. You will get a message if the product is moved on the other side of the GeoFence.

1. Put the product in the center of the work area.
2. Do steps 1–3 in *To get access to the menu in the display of the product on page 22*.
3. Use the **arrow buttons** and the **OK** button to move through the menu structure *Accessories > Automower Connect > GeoFence > Activate GeoFence*.
4. Push the **OK** button.
5. Select *Activate GeoFence* and push the **OK** button.

To set a new center point for the Geofence function

1. Put the product in the center of the work area.
2. Do steps 1–3 in *To get access to the menu in the display of the product on page 22*.
3. Use the **arrow buttons** and the **OK** button to move through the menu structure *Accessories > Automower Connect > GeoFence > New center point*.
4. Push the **OK** button.

To set the GeoFence level of sensitivity

The higher level of GeoFence sensitivity, the easier the alarm starts.

1. Do steps 1–3 in *To get access to the menu in the display of the product on page 22*.
2. Use the **arrow buttons** and the **OK** button to move through the menu structure *Accessories > Automower Connect > GeoFence*.
3. Use the **arrow buttons** to select level of GeoFence sensitivity.
4. Push the **BACK** button.

To use the SMS function

The SMS function sends you an SMS when the product is moved out of the GeoFence.

1. Do steps 1–3 in *To get access to the menu in the display of the product on page 22*.
2. Use the **arrow buttons** and the **OK** button to move through the menu structure *Accessories > Automower Connect > Communication > Use SMS*.
3. Push the **OK** button.

4. Use the **arrow** buttons and the **OK** button to move through the menu structure *Accessories > Automower Connect > Communication > SMS phone numbers*.
5. Push the **number** buttons to enter the telephone number with country code. For example (+)46701234567.
6. Push the **BACK** button.

Note: There is a maximum of 10 SMS each month from the product.

Network

APN settings

The product must specify APN settings to be able to use and send data via the mobile net. Settings for Husqvarna SIM is default.

3.12.10.3 Ultrasonic Automower® 450X

The *Ultrasonic* function makes the product decrease speed when the product comes near an obstacle. The product operates at a lower speed if the *Ultrasonic* function is disabled.

To set the Ultrasonic function

1. Do steps 1–3 in *To get access to the menu in the display of the product on page 22*.
2. Use the **arrow** buttons and the **OK** button to move through the menu structure *Accessories > Ultrasonic > Use*.

3.12.10.4 Headlights

To set the schedule for the headlights

1. Do steps 1–3 in *To get access to the menu in the display of the product on page 22*.
2. Use the **arrow** buttons and the **OK** button to move through the menu structure *Accessories > Headlights > Schedule*.
3. Select between *Always ON*, *Evening only* (19:00-00:00), *Evening & night* (19:00-07:00) or *Always OFF*.

To set the Flashes when fault function

The headlights flashes if the product stops to operate because of a fault if *Flashes when fault* is enabled.

1. Do steps 1–3 in *To get access to the menu in the display of the product on page 22*.
2. Use the **arrow** buttons and the **OK** button to move through the menu structure *Accessories > Headlights > Flashes when fault*.
3. Use the **OK** button to enable or disable the *Flashes when fault* function.

3.12.10.5 To avoid collisions with the Automower® house

The wear on the product and the Automower® house decreases when you select *Avoid collisions with mower*.

1. Do steps 1–3 in *To get access to the menu in the display of the product on page 22*.
2. Use the arrow buttons and the **OK** button to move through the menu structure *Accessories > Mower house > Avoid collisions with mower*.

Note: If *Avoid collisions with mower* is selected it can result in grass that is not cut around the charging station.

3.12.10.6 FlexiFence

If you install the FlexiFence accessory, you must enable the Zone generator function of the product.

To enable the Zone generator function

1. Do steps 1–3 in *To get access to the menu in the display of the product on page 22*.
2. Use the **arrow** buttons and the **OK** button to move through the menu structure *Settings > Installation > Zone generator*.
3. Push the **OK** button to enable *Zone generator*.
4. Push the **BACK** button.

4 Operation

4.1 Main switch



WARNING: Read the safety instructions carefully before you start the product.



WARNING: Keep your hands and feet away from the rotating blades. Do not put your hands or feet near to or below the product when the cutting motor is on.



WARNING: Do not use the product when persons, especially children, or animals are in the work area.

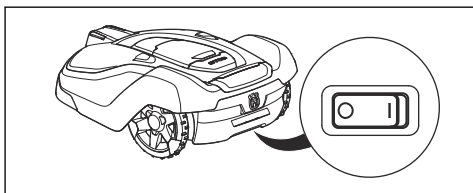

- Set the **Main switch** in the *1* position to start the product.
- Set the **Main switch** in the *0* position when the product is not in use or before you do inspection or maintenance on the product.

4.2 To start the product

1. Push the **STOP** button to open the hatch on the product.
2. Set the **Main switch** to position *1*.
3. Enter the PIN code.
4. Push the **START** button.

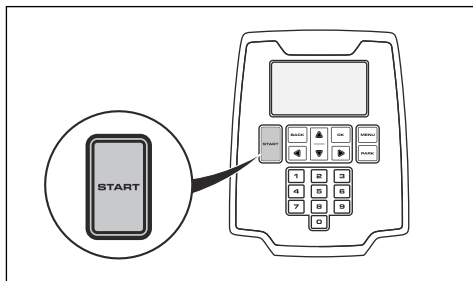

5. Select an operating mode. Refer to *Operating modes - Start* on page 33.

6. Push the **OK** button.
7. Close the hatch on the product.

Note: If the product is parked in the charging station, the product will start to operate when the battery is fully charged and if the *Schedule* settings is set for operation.

Note: The first weeks after installation the perceived sound level when cutting the grass may be higher than expected. When the product has cut the grass for some time, the perceived sound level is much lower.

4.3 Operating modes - Start

- *Main area*
- *Secondary area*
- *Override schedule*
- *Spot cutting*

4.3.1 Main area

Use the operating mode *Main area* for the product to cut and charge automatically.

4.3.2 Secondary area

Use *Secondary area* operating mode to cut secondary areas. You must move the product manually between the main area and the secondary area. The product cuts for a selected period of time or until the battery is empty.

Note: You must put the product manually in the charging station to charge the product when it is in a secondary area. The product will move out from the charging station and stop when the battery is charged. You must select an operating mode to start the product.

Note: If you will cut the main area after the battery is charged, set the product to *Main area* mode before you put the product in the charging station.

4.3.3 Override schedule

Use the operating mode *Override schedule* to temporarily override the *Schedule* settings for *24h* or *3 days*.

Note: It is not possible to cut more than the maximum cutting time for each day. Refer to *To calculate the suitable operating hours* on page 23.

4.3.4 Spot cutting

Use the operating mode *Spot cutting* to cut a selected area in a spiral pattern. You must move the product manually to the selected area before you start the *Spot cutting* operating mode.

Note: After the product has operated in the operating mode *Spot cutting*, it will automatically start to cut in the operating mode *Main area* or *Secondary area*.

4.4 To park the product

1. Push the **STOP** button to open the hatch.
2. Set the **Main switch** to position 0.
3. Enter the PIN code.
4. Push the **PARK** button.
5. Select an operating mode. Refer to *Operating modes - Park on page 34*.
6. Push the **OK** button.
7. Close the hatch.

4.4.1 Operating modes - Park

- *Park until further notice*
- *Start with schedule*

4.4.1.1 Park until further notice

Use the operating mode *Park until further notice* for the product to go back to the charging station. The product will stay in the charging station until you select a new operating mode.

4.4.1.2 Start again with next schedule

Use the operating mode *Start again with next schedule* for the product to go back to the charging station. The product will stay in the charging station until the next *Schedule* setting.

4.5 To stop the product

1. Push the **STOP** button to make the product and the cutting motor stop.

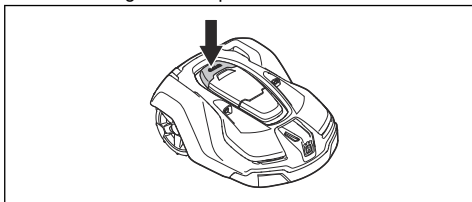

4.6 To switch off the product

1. Push the **STOP** button on top of the product.
2. Set the **Main switch** to position 0.

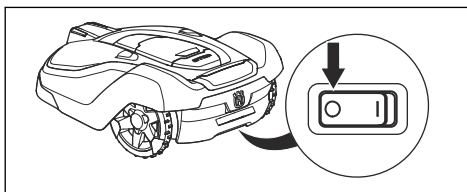

4.7 To charge the battery



WARNING: Only charge the product using a charging station which is intended for it. Incorrect use may result in electric shock, overheating or leakage of corrosive liquid from the battery.

In the event of leakage of electrolyte flush with water and seek medical help if it comes in contact with the eyes etc.

When the product is new or has been stored for a long period, the battery can be empty and needs to be charged before starting. In the *Main area* mode, the product automatically alternates between mowing and charging.

1. Set the **Main switch** to position 1.
2. Place the product in the charging station. Slide the product in as far as possible to ensure proper contact between the product and the charging station. Refer to contact and charging plates in *Product overview on page 4*
3. The display shows a message that charging is in progress.

5 Maintenance

5.1 Introduction - maintenance



WARNING: The product must be switched off before any maintenance is done.



WARNING: Wear protective gloves.

For better operation and longer service life, make sure to clean the product regularly and replace worn parts. All maintenance and servicing must be done according to Husqvarna's instructions. Refer to *Warranty on page 53*.

When the product is first used, the blade disc and blades should be inspected once a week. If the amount of wear during this period has been low, the inspection interval can be increased.

It is important that the blade disc rotates easily. The edges of the blades should not be damaged. The lifetime of the blades varies immensely and depends for instance on:

- Operating time and size of the work area.
- Type of grass and seasonal growth.
- Soil, sand and use of fertilizers.
- The presence of objects such as cones, windfalls, toys, tools, stones, roots and the like.

The normal life is 3 to 6 weeks when used under favorable conditions. Refer to *Replacement of the blades on page 36* on how to replace the blades.

Note: Working with blunt blades gives a poorer mowing result. The grass is not cut cleanly and more energy is needed resulting in the product not mowing such a large area.

5.2 Clean the product



CAUTION: Never use a high-pressure washer to clean the product. Never use solvents for cleaning.

The product does not operate satisfactorily in slopes if the wheels are blocked with grass. Use a soft brush to clean the product.

Husqvarna recommends to use a special cleaning and maintenance kit, available as accessory. Speak to your Husqvarna representative for more information.

5.2.1 Chassis and blade disc

Inspect the blade disc and blades once a week.

1. Push the **STOP** button.
2. Set the **Main switch** to position 0.
3. Lift the product onto its side.
4. Clean the blade disc and chassis using for example a dish brush. At the same time, check that the blade disc rotates freely in relation to the foot guard. Also, check that the blades are intact and can pivot freely.

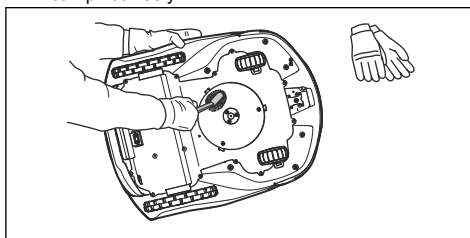

5.2.2 To clean the wheels

The product does not operate satisfactorily in slopes if the wheels are blocked with grass.

- Use a soft brush to clean the wheels.

5.2.3 To clean the body of the product

- Use a moist cloth and a weak soap solution to clean the body of the product.

5.2.4 To clean the charging station



WARNING: Disconnect the power supply from the power outlet before maintenance, or when you clean the charging station or power supply.



CAUTION: Do not use a high-pressure washer or running water to clean the charging station.

Note: The product cannot enter the charging station if there are objects in the charging station. Clean the charging station regularly.

- Remove grass, twigs and other objects from the charging station.

5.3 Replacement of the blades



WARNING: Husqvarna can only guarantee safety if you use Husqvarna original blades with the embossed crowned H-mark logotype.

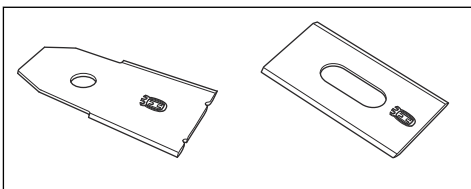

WARNING: You must replace the screws when you replace the blades. The used screws can wear quickly and make the blade come loose, this can cause serious injury.

Replace worn or damaged blades for a safe operation. Replace the blades regularly for a satisfactory cut result and a low energy use. All 3 blades and screws must be replaced at the same time to get a balanced cutting system.

5.3.1 To replace the blades

1. Push the **STOP** button
2. Set the **Main switch** to position 0.

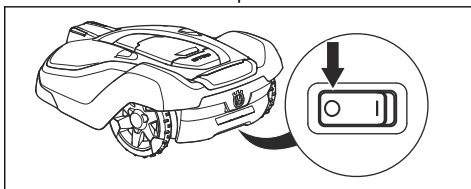

3. Turn the product upside down. Put the product on a soft and clean surface to avoid scratching the product.
4. Rotate the skid plate so that its holes align with the screws for the blade.
5. Remove the 3 screws with a screwdriver.

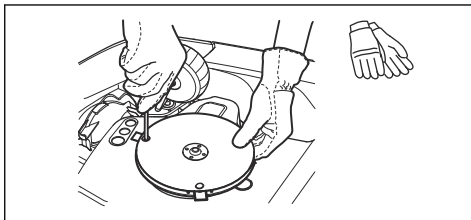

6. Remove the 3 blades.

7. Attach 3 new blades and screws.
8. Make sure that the blades can pivot freely.

5.4 Battery



CAUTION: Charge the battery fully before you put the product into storage. If the battery is not fully charged it can cause damage to the battery.

If the operating time of the product is shorter than usual between charges, this means that the battery is at the end of its life cycle. Replace the battery to extend the operating time.

Note: The battery life is related to the length of the season and how many hours a day the product operates. A long season or many hours of operation a day means that the battery must be replaced more regularly.

5.5 Winter service

Take your product to your Husqvarna central service for service prior to winter storage. Regular winter service will maintain the product in good condition and create the best conditions for a new season without any disruptions.

Service usually includes the following:

- Thorough cleaning of the body, the chassis, the blade disc and all other moving parts.
- Testing of the product's function and components.
- Checking and, if required, replacing wear items such as blades and bearings.
- Testing the product's battery capacity as well as a recommendation to replace battery if necessary.
- If new firmware is available, the product is updated.

6 Troubleshooting

6.1 Introduction - troubleshooting

In this chapter you can find information and help about faults and symptoms of the product. You can find more information and FAQ (Frequently Asked Questions) on www.husqvarna.com.

6.2 Fault messages

The list below shows a number of fault messages that may be shown in the app. Speak to your local Husqvarna representative if the same message shows frequently.

Message	Cause	Action
<i>Wheel motor blocked</i>	Grass or other objects is wound around the drive wheel.	Examine the drive wheel and remove the grass or other object.
<i>Cutting system blocked</i>	Grass or other objects is wound around the blade disc.	Examine the blade disc and remove the grass or other object.
	The blade disc are in a pool of water.	Move the product and prevent the collection of water in the work area.
<i>Cutting height blocked</i>	Grass or other objects is wound around the cutting height adjustment, or between the blade disc and chassis.	Examine the blade disc and the bellows around the cutting height adjustment, and remove any grass or other objects that may have got stuck.
<i>Trapped</i>	The product is blocked in a small area behind a number of obstacles.	Examine if there are obstacles which make it hard for the product to move away from this location.

Message	Cause	Action
<i>No loop signal</i>	The power supply or the low-voltage cable is not connected.	Examine the LED status on the charging station. If there is no power to the charging station, the LED is not lit. Examine the power outlet connection and if a residual-current device is engaged. Make sure that the low-voltage cable is connected to the charging station.
	The power supply or the low-voltage cable is damaged.	Replace the power supply or low-voltage cable.
	The boundary wire is not connected to the charging station.	Make sure that the boundary wire connectors are fitted properly to the charging station. Replace connectors if damaged. Refer to <i>To install the boundary wire on page 19</i> .
	Boundary wire broken.	Examine the LED on the charging station. If the LED indicates that there is a break in the boundary wire, find out where the break is. Replace the damaged section of the loop with a new loop wire. Use an original coupler to make a splice of the loop ends. Refer to <i>Find breaks in the loop wire on page 46</i> .
	<i>ECO mode</i> is activated and the product has attempted to start outside the charging station.	Put the product in the charging station. Start the product. Refer to <i>To start the product on page 33</i> .
	The boundary wire is crossed on its way to and from an island.	Make sure that the boundary wire is put down correctly. Refer to <i>To make an island on page 17</i> .
	The product does not find the loop signal from the charging station.	Put the product in the charging station and generate a new loop signal. Refer to <i>To create a New loop signal on page 24</i> .
	Disturbances from metal objects (fences, reinforcement steel) or buried cables close by.	Try to move the boundary wire and/or make more islands in the work area to increase the signal strength.
The product is too far from the boundary wire.	Redo the installation of the boundary wire so that all parts of the work area is maximum 35 m / 115 ft. from the boundary wire.	
<i>Wrong PIN code</i>	An incorrect PIN code has been entered. 5 tries are permitted, and the product is then blocked for a period of time.	Enter the correct PIN code. If the PIN code is lost, use the link in the app to send the PIN code to your registered e-mail address. If you have not registered the e-mail address, speak to your authorized service center.

Message	Cause	Action
<i>Outside work area</i>	The boundary wire connections to the charging station are crossed.	Make sure that the boundary wire is connected correctly to the charging station. Refer to <i>To install the boundary wire on page 19</i> .
	The boundary wire is too close to the edge of the work area.	Make sure that the boundary wire is put down correctly. Refer to <i>To install the boundary wire on page 19</i> .
	The work area slopes too much by the boundary loop.	
	The boundary wire is laid in the wrong direction around an island.	
	Disturbances from metal objects (fences, reinforcement steel) or buried cables close by.	Try to move the boundary wire and/or make more islands in the work area to increase the signal strength.
	The product finds it hard to distinguish the signal from another product installation close by.	Put the product in the charging station and generate a new loop signal. Refer to <i>To create a New loop signal on page 24</i> .
<i>Empty battery</i>	The product cannot find the charging station.	Change the position of the guide wire. Refer to <i>To install the guide wire on page 20</i> .
		Check the installation settings about how to find the charging station. Refer to <i>To set how the product finds the charging station on page 27</i> .
	The battery is spent.	Replace the battery. Refer to <i>Battery on page 36</i> .
	The charging station's antenna is defective.	Check if the indicator lamp in the charging station flashes red. Refer to <i>Indicator lamp in the charging station on page 44</i> . This problem requires action by authorized service technician.
<i>Slipped/No drive</i>	The product has hit an obstacle and stopped or the wheels cannot move on the wet grass.	Free the product and rectify the reason for the lack of drive. If it is due to wet grass, wait until the lawn has dried before using the product.
	The work area includes a steep slope.	Maximum guaranteed slope is %. Steeper slopes should be isolated. Refer to <i>To put the boundary wire in a slope on page 16</i> .
	The guide wire is not laid at an angle on a slope.	If the guide wire is laid on a slope, it must be laid at an angle across the slope. Refer to <i>To make a secondary area on page 17</i> .
<i>Wheel motor overloaded</i>	Grass or other objects is wound around the drive wheel.	Examine the drive wheel and remove grass or other objects.

Message	Cause	Action
<i>Charging station blocked</i>	The contact between the charging strips and contact strips may be poor and the product has made a number of attempts to charge.	Put the product in the charging station and check that the charging plates and contact plates make good contact.
	An object is obstructing the product.	Remove the object.
	The charging station is tilted or bent.	Confirm that the charging station is placed on a fully flat and horizontal ground. The charging station must not be tilted or bent.
<i>Stuck in charging station</i>	The product slips on the baseplate.	Clean the baseplate.
	There is an object in the way of the product preventing it from leaving the charging station.	Remove the object.
<i>Upside down</i>	The product is leaning too much or has turned over.	Turn the product the right way up.
<i>Mower tilted</i>	The product is tilted more than the maximum angle.	Move the product to a flat area.
<i>Needs manual charging</i>	The product is set to the <i>Secondary area</i> operating mode.	Place the product in the charging station. This behavior is normal and no action is required.
<i>Next start hh:mm</i>	The schedule setting prevents the product from operating.	Change the schedule settings. Refer to <i>Schedule on page 23</i> .
	The clock on the product is not correct.	Set the time. Refer to <i>To set the time & date on page 30</i> .
<i>Lifted</i>	The lift sensor is engaged because the product hit an object or/and is blocked.	Free the product. If the problem stays, speak to your approved servicing dealer.
<i>Collision sensor problem, front/rear</i>	The body of the product can not move freely around its chassis.	Remove dirt or objects between the chassis and the body to make sure that the body can move freely around the chassis.
	The product has become stuck.	Free the product and rectify the reason.
<i>Wheel motor blocked right/left</i>	Grass or other object is wrapped around the drive wheel.	Clean the wheels and around the wheels.
<i>Alarm! Mower switched off</i>	The alarm was activated because the product was switched OFF.	Adjust the mower security settings in the <i>Security</i> menu. Refer to <i>Security level on page 24</i> .
<i>Alarm! Mower stopped</i>	The alarm was activated because the product was stopped.	
<i>Alarm! Mower lifted</i>	The alarm was activated because the product was lifted.	
<i>Alarm! Mower tilted</i>	The alarm was activated because the product was tilted.	
<i>Alarm! Outside GeoFence</i>	The alarm was activated because the product was outside the GeoFence.	

Message	Cause	Action
<i>Electronic problem</i>	Temporary electronic or firmware related issue in the product.	Restart the product. If the problem stays, speak to your approved servicing dealer.
<i>Loop sensor problem, front/rear</i>		
<i>Charging system problem</i>		
<i>Tilt sensor problem</i>		
<i>Temporary problem</i>		
<i>Wheel drive problem, right/left</i>		
<i>Invalid device combination</i>		
<i>Ultrasonic problem</i>		
<i>GPS navigation problem</i>		
<i>Temporary battery problem</i>		
<i>Faulty mix of batteries</i>		
<i>Battery problem</i>	Temporary battery or firmware related issue in the product.	Restart the product. If the problem stays, speak to your approved servicing dealer.
	Wrong type of battery	Use only original batteries recommended by the manufacturer.
<i>Battery temperature outside limits</i>	The product does not operate if the battery temperature is too high or too low.	The product starts to operate again when the temperature is between the set limits and the schedule settings let the product to operate. Make sure that the charging station is put in an area with protection from the sun.
<i>Charging current too high</i>	Wrong or faulty power supply unit.	Restart the product. If the problem stays, speak to your approved servicing dealer.
<i>Connectivity problem</i>	Potential problem on the connectivity circuit board in the product.	Restart the product. If the problem stays, speak to your approved servicing dealer.

Message	Cause	Action
<i>Zone generator problem</i> <i>FlexiFence problem</i>	The battery of the FlexiFence accessory is low. The FlexiFence accessory does not operate when the battery is empty. The product can cut in the stay-out zone if you start the product before you charge the FlexiFence accessory.	Park the product and charge the FlexiFence accessory before you start the product.
	The temperature in the zone generator accessory is a higher than the maximum limit and is set to off.	Put the product in an area with protection from the sun. Let the temperature of the zone generator accessory decrease before you start the product.
<i>Cutting system major imbalance</i>	The product has discovered vibrations in the blade disc	Continued operation can cause damage to the cutting system. Examine that the blades and screws are not damaged or worn. Make sure that all blades are correctly installed and that there is only one blade attached in each position on the blade disc.

6.3 Information messages

The list below shows a number of information messages that may be found in the *Messages* menu in the Automower® Connect app. Contact your local Husqvarna representative if the same message appears often.

Message	Cause	Action
<i>Low battery</i>	The product cannot find the charging station.	Change the position of the guide wire. Refer to <i>To install the boundary wire on page 19</i> . Make sure that the installation settings about how to find the charging station is correct. Refer to <i>To set how the product finds the charging station on page 27</i> .
	The battery is spent.	Replace the battery. Refer to <i>Battery on page 36</i> .
	The charging station's antenna is defective.	Check if the indicator lamp in the charging station flashes red. Refer to <i>To replace the blades on page 36</i> . This problem requires action by authorized service technician.
<i>Settings restored</i>	Confirmation that a <i>Reset all user settings</i> has been carried out.	This is normal. No action required.
<i>Limited cutting height</i> <i>Unexpected cutting height adj</i> <i>Limited cutting height range</i> <i>Cutting height problem</i> <i>Cutting height blocked</i>	The cutting height adjustment cannot move.	Examine the cutting height adjustment and remove grass or other objects. If the problem stays, speak to your approved servicing dealer.

Message	Cause	Action
<i>Cutting system imbalance</i>	The product has discovered vibrations in the blade disc.	Verify that the blades and screws are intact and not worn out. Verify that all blades are correctly mounted. Check that no double blades are mounted on any of the three blade positions.
<i>Slope too steep</i>	The product stopped because the slope is too steep.	Change the installation of the boundary wire to not include this steep part of the work area. Refer to <i>To install the boundary wire on page 19</i> .
<i>Guide 1 not found</i> <i>Guide 2 not found</i> <i>Guide 3 not found</i>	The guide wire is not connected to the charging station.	Check that the guide wire's connector is tightly connected to the charging station. Refer to <i>To install the guide wire on page 20</i> .
	Break in the guide wire.	Find out where the break is. Replace the damaged section of the guide wire with a new loop wire and splice using an original coupler.
	The guide wire is not connected to the boundary loop.	Check that the guide wire is connected correctly to the boundary loop. Refer to <i>To install the boundary wire on page 19</i> .
<i>Guide calibration failed</i>	The product has failed to calibrate the guide wire.	Check that the guide wires are installed according to the instructions. Refer to <i>To install the boundary wire on page 19</i> . The next time the product moves out from the charging station, a new guide calibration is done.
<i>Guide calibration accomplished</i>	The product has succeeded to calibrate the guide wire.	No action required.
<i>GPS navigation problem</i>	Problem with the GPS assisted navigation equipment.	Contact your local Husqvarna representative if this message appears often.
<i>Weak GPS signal</i>	The sky is blocked in large parts of the work area.	If possible, remove objects that can cause a blockage of the GPS signal. Disable the GPS navigation function and use the lawn coverage function. Refer to <i>Lawn Coverage on page 26</i> .
<i>Difficult finding home</i>	The product has been following the boundary wire several laps without finding the charging station.	The installation has not been done correctly. Refer to <i>To install the boundary wire on page 19</i> . Wrong corridor width setting on boundary wire. Refer to <i>To install the boundary wire on page 19</i> . The product was started on a Secondary area with the Main area setting.
<i>Temporary problem with the server.</i>	Please try again.	Contact your local Husqvarna representative if this message appears often.
<i>Connection settings restored</i>	Settings for wireless connectivity have been restored due to an error.	Check and revise settings if necessary.

Message	Cause	Action
<i>SIM card requires PIN</i>	The SIM card must be unlocked.	Make sure the correct SIM PIN has been entered into the mower's menu (Network > SIM card). Contact your local Husqvarna representative if this message appears often.
<i>SIM card locked</i>	The SIM card must be replaced.	Contact your local Husqvarna representative.
<i>SIM card not found</i>	Automower® Connect requires a SIM card to be inserted in the mower.	Contact your local Husqvarna representative.
<i>GeoFence problem</i>	The GeoFence is not work due to poor (or no) communication with the system.	Contact your local Husqvarna representative.

6.4 Indicator lamp in the charging station

The indicator lamp in the charging station must show a solid or flashing green light for a correct installation. If not, follow the instructions in the troubleshooting guide below.

Speak to your Husqvarna customer service for more information.

Light	Cause	Action
Green solid light	Good signals	Usual operation of the product.
Green flashing light	The signals are good and <i>ECO mode</i> is enabled.	Usual operation of the product. Refer to <i>ECO mode on page 29</i> .
Blue flashing light	The boundary wire is not connected to the charging station.	Make sure that the boundary wire is correctly installed in the charging station. Refer to <i>To install the boundary wire on page 19</i> .
	Damage in the boundary wire.	Find out where the damage is. Replace the damaged section with new boundary wire.
Red flashing light	Interference in the antenna of the charging station.	Speak to your Husqvarna customer service.
Red solid light	Error in the circuit board or incorrect power supply in the charging station. The error must be corrected by an authorized service technician.	Speak to your Husqvarna customer service.

6.5 Symptoms

If your product does not work as expected, follow the symptoms guide below.

There is a FAQ (Frequently Asked Questions) on www.husqvarna.com which provides more detailed answers to a number of standard questions. Contact Husqvarna customer service if you still cannot find the reason for the fault.

Symptoms	Cause	Action
The product has difficulty docking.	The guide wire is not laid in a long straight line that is far enough out from the charging station.	Check that the charging station has been installed according to the instructions in <i>To examine where to put the boundary wire on page 15</i>
	The guide wire is not inserted in the slot under the charging station.	Make sure that the guide wire is in the correct position below the charging station. Refer to <i>To install the guide wire on page 20</i> .
	The charging station is not on a level surface.	Place the charging station on a surface that is entirely level. Refer to <i>To examine where to put the charging station on page 14</i> .
The product runs at the wrong time	The clock or the date in the product is not correct.	Set the clock or date. Refer to <i>To set the time & date on page 30</i> .
	The start and stop times for mowing are incorrect.	Change the <i>Schedule</i> settings. Refer to <i>Schedule on page 23</i> .
The product vibrates.	Damaged blades lead to imbalance in the cutting system.	Inspect the blades and screws and replace them if necessary. Refer to <i>Replacement of the blades on page 36</i> .
	Too many blades in the same position lead to imbalance in the cutting system.	Check that only one blade is fitted at each screw.
	Different versions (thickness) of blades are used.	Check if the blades are of different versions.
The product runs, but the blade disc does not rotate.	The product searches for the charging station, or is reversing out of the charging station.	No action. The blade disc does not rotate when the product is searching for the charging station.
The product mows for shorter periods than usual between charges.	Grass or other foreign object blocks the blade disc.	Remove and clean the blade disc. Refer to <i>Chassis and blade disc on page 35</i> .
	The battery is spent.	Replace the battery. Refer to <i>Battery on page 36</i> .
	Dull blades. More energy is needed when cutting the grass.	Replace the blades. Refer to <i>Replacement of the blades on page 36</i> .
Both the mowing and charging times are shorter than usual.	The battery is spent.	Replace the battery. Refer to <i>Battery on page 36</i> .

Symptoms	Cause	Action
The product is parked for hours in the charging station.	The hatch is closed but the START button is not pushed.	Push the STOP button to open the hatch. Enter the PIN code and confirm with the OK button. Push the START button and then close the hatch.
	Parking mode is activated.	Change the operating mode. Refer to <i>Operating modes - Park on page 34</i> .
	The product is not allowed to operate if the battery temperature is too high or too low.	Check that the charging station is placed in an area with protection from the sun.
Uneven mowing results.	The product works too few hours per day.	Increase the mowing time. Refer to <i>Schedule on page 23</i> .
	The shape of the work area requires the use of <i>Lawn coverage</i> function for the product to find its way to all remote areas.	Steer the product to a remote area. Refer to <i>Lawn Coverage on page 26</i> .
	The <i>How often?</i> setting is incorrect in relation to the layout of the work area.	Check that the correct <i>How often?</i> value is selected.
	The work area is too large.	Try limiting the work area or extending the schedule. Refer to <i>Schedule on page 23</i> .
	Dull blades.	Replace all the blades. Refer to <i>Replacement of the blades on page 36</i> .
	Long grass in relation to the set cutting height.	Increase the cutting height and then successively lower it.
	Accumulation of grass by the blade disc or around the motor shaft.	Check that the blade disc rotates freely and easily. If not, screw off the blade disc and remove grass and foreign objects. Refer to <i>Chassis and blade disc on page 35</i> .

6.6 Find breaks in the loop wire

Breaks in the loop wire are usually the result of unintentional physical damage to the wire such as when gardening with a shovel. In countries with ground frost, also sharp stones that move in the ground can damage the wire. Breaks can also occur due to the wire being stretched excessively during installation.

Mowing the grass too low right after the installation can damage wire insulation. Damage to the insulation may not cause disruptions until several weeks or months later. To avoid this, always select the maximum cutting height the first weeks after installation and then lower the height one step at a time every second week until the desired cutting height has been reached.

A defective splicing of the loop wire can also lead to disruptions several weeks after the splice was done. A faulty splice can, for example, be the result of the coupler not being pressed together hard enough with a pair of pliers, or that a coupler of lower quality than the original coupler has been used. Please first check all known splices before further troubleshooting is done.

A wire break can be located by gradually halving the distance of the loop where the break may have occurred until there is only a very short section of the wire left.

The following method does not work if *ECO mode* is activated. Make sure first that *ECO mode* is switched off. Refer to *ECO mode on page 29*.

1. Check that the indicator lamp in the charging station flashes blue, which indicates a break in the boundary loop. Refer to *Indicator lamp in the charging station on page 44*.

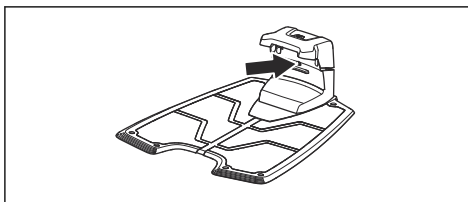

2. Check that the boundary wire connections to the charging station are properly connected and not damaged. Check that the indicator lamp in the charging station is still flashing blue.

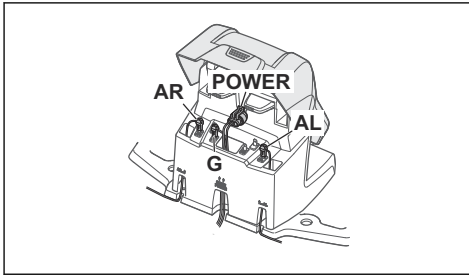

3. Switch the connections between the guide wire and the boundary wire in the charging station.

Start by switching connection and .

If the indicator lamp has a solid green light, then the break is somewhere on the boundary wire between and the point where the guide wire is connected to the boundary wire (thick black line in the illustration).

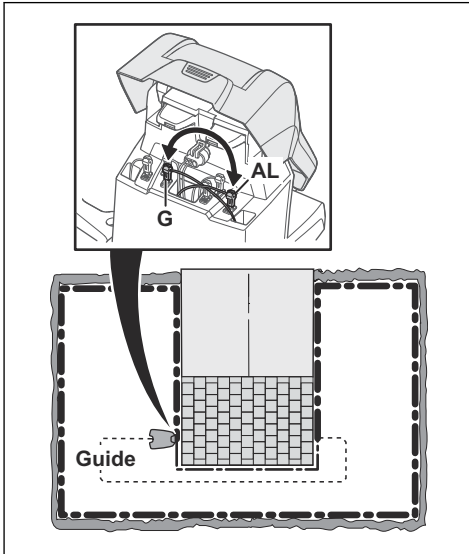

To rectify the fault you will need boundary wire, connector(s) and coupler(s):

- a) If the suspected boundary wire is short then it is easiest to exchange all of the boundary wire between and the point where the guide wire is connected to the boundary wire (thick black line).
- b) If the suspected boundary wire is long (thick black line) then do as follows: Put and back to their original positions. Then disconnect . Connect a new loop wire to . Connect the other end of this new loop wire at the middle of the suspected wire section.

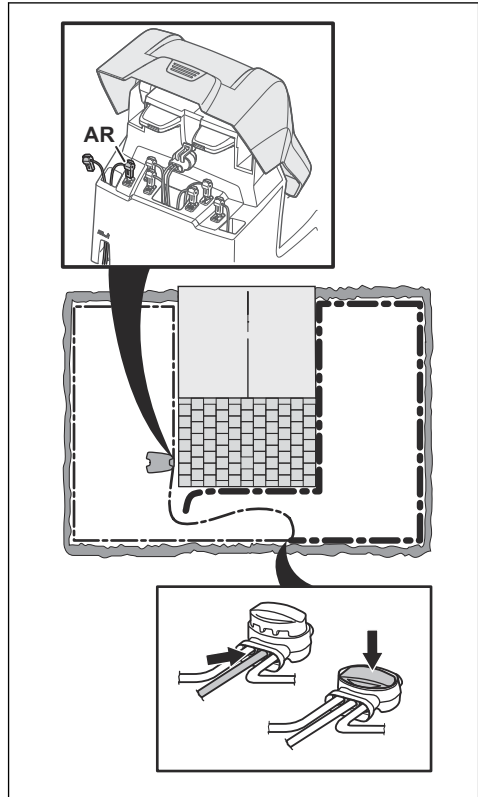

If the indicator lamp now is green, then the break is somewhere in the wire between the disconnected end to the point where the new wire is connected (thick black line below). In that case, move the connection for the new wire closer to the disconnected end (roughly at the middle of the suspected wire section) and check again if the indicator lamp is green.

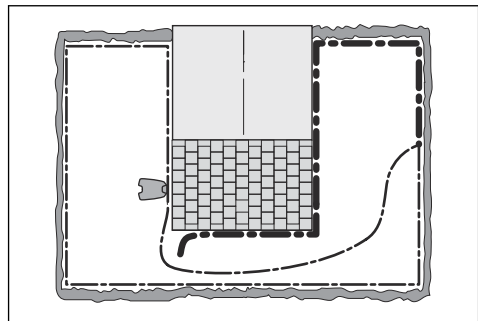

Continue until only a very short section of the wire remains which is the difference between a solid green light and a flashing blue light. Then follow instruction in step 5 below.

4. If indicator lamp still flashes blue in step 3 above: Put and back in their original positions. Then switch and . If indicator lamp now is lit with a solid green light then disconnect and connect a new boundary wire to . Connect the other end of this new wire at the middle of the suspected wire section. Follow the same approach as in 3a) and 3b) above.
5. When the break is found, the damaged section must be replaced with a new wire. Always use original couplers.

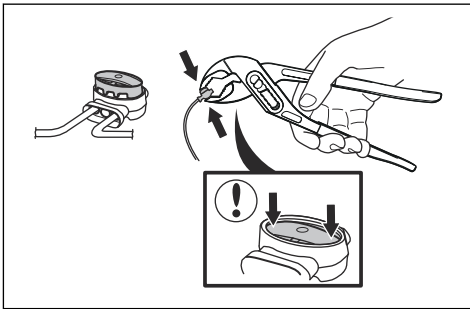

7 Transportation, storage and disposal

7.1 Transportation

The supplied Li-ion batteries obey the Dangerous Goods Legislation requirements.

- Obey all applicable national regulations.
- Obey the special requirement on package and labels for commercial transportations, including by third parties and forwarding agents.

7.2 Storage

- Fully charge the product. Refer to *To charge the battery on page 34*.
- Switch off the product. Refer to *To switch off the product on page 34*.
- Clean the product. Refer to *Clean the product on page 35*.
- Keep the product in a dry, frost free space.
- Keep the product with all wheels on level ground during storage, or use a wall hanger.
- If you keep the charging station indoors, disconnect and remove the power supply and all the connectors from the charging station. Put the end of each connector wire in a connector protection box.

Note: If you keep the charging station outdoors, do not disconnect the power supply and the connectors.

- Contact Husqvarna sales representative about what accessories are available for your product.

7.3 Disposal

- Obey the local recycling requirements and applicable regulations.
- For questions about how to remove the battery, refer to *To remove the battery on page 49*.

7.3.1 To remove the battery



CAUTION: Only remove the battery when you dispose the product. When you remove the warranty seal, the Husqvarna warranty is no longer applicable.

1. Switch off the product. Refer to *To switch off the product on page 34*.
2. Pull out the grommet on the charging cable at the very front of the product, and carefully remove the connector.
3. Lift the cover, one corner at a time.
4. Remove the 14 screws with a Torx 20.

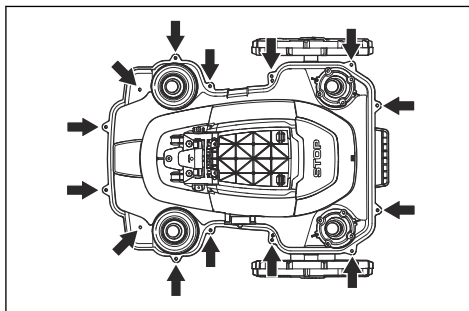

5. Lift the rear edge of the top section of the chassis.
6. Disconnect the cable from the main circuit board.
7. Remove the top section of the chassis.
8. Remove the 4 screws that hold the battery with a Torx 20.

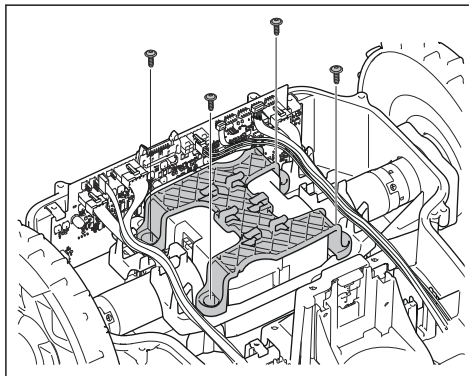

9. Disconnect the battery connection from the main circuit board.
10. Open the battery cover and remove the battery.

8 Technical data

8.1 Technical data

Dimensions	Automower® 420	Automower® 430X	Automower® 440	Automower® 450X
Length, cm / in.	72 / 28.3	72 / 28.3	72 / 28.3	72 / 28.3
Width, cm / in.	56 / 22.0	56 / 22.0	56 / 22.0	56 / 22.0
Height, cm / in.	31 / 12.2	31 / 12.2	31 / 12.2	31 / 12.2
Weight, kg / lbs	11.5 / 25	13.2 / 29	12 / 27	13.9 / 31

Electrical system	Automower® 420	Automower® 430X	Automower® 440	Automower® 450X
Battery, Lithium-Ion 18.5 V/3.0 Ah Art. No.	580 68 33-01			
Battery, Lithium-Ion 18.5 V/4.0 Ah Art. No.	580 68 33-02, 593 11 41-06			
Battery, Lithium-Ion 18 V/4.0 Ah Art. No.	580 68 33-03, 593 11 41-02, 593 11 42-01, 593 11 41-04, 593 11 41-05			
Battery, Lithium-Ion 18.25 V/4.0 Ah Art. No.	580 68 33-04, 593 11 41-03, 593 11 42-02			
Battery, Lithium-Ion 18 V/5.2 Ah Art. No.		588 14 64-01	588 14 64-01 (2 pcs.) 5.2 Ah/ battery	588 14 64-01 (2 pcs.) 5.2 Ah/ battery
Battery, Lithium-Ion 18 V/5.0 Ah Art. No.		593 11 84-01, 593 11 85-01, 593 11 84-03, 588 14 64-02, 593 11 84-04, 596 11 84-05	588 14 64-02, 593 11 84-01, 593 11 84-03, 593 11 85-01, 593 11 84-04, 593 11 84-05 (2 pcs.) 5.0 Ah/ battery	593 11 84-01, 588 14 64-02, 593 11 84-03, 593 11 85-01, 593 11 84-04, 593 11 84-05 (2 pcs.) 5.0 Ah/ battery
Battery, Lithium-Ion 18 V/4.9 Ah Art. No.		593 11 84-02, 593 11 85-02, 588 14 64-03	588 14 64-03, 593 11 84-02, 593 11 85-02, (2 pcs.) 4.9 Ah/ battery	593 11 84-02, 588 14 64-03, 593 11 85-02 (2 pcs.) 4.9 Ah/ battery
Power supply (28V DC), V AC	100-240	100-240	100-240	100-240
Low-voltage cable length, m / ft.	10 / 33	10 / 33	10 / 33	10 / 33
Mean energy consumption at maximum use	17 kWh/month for a work area of 2200 m ² / 0.55 acre	18 kWh/month for a work area of 3200 m ² / 0.8 acre	20 kWh/month for a work area of 4000 m ² / 1 acre	23 kWh/month for a work area of 5000 m ² / 1.25 acres

Electrical system	Automower® 420	Automower® 430X	Automower® 440	Automower® 450X
Charging current, A DC	2.2	4.2	7	7
Type of Power Supply Unit ⁵	ADP-60JR XX, FW7438/28/D/X X/Y	ADP-120DRXX, FW7448/28/D/X X/Y	ADP-200JR XX, FW7458/28/D/X X/Y	ADP-200JR XX, FW7458/28/D/X X/Y
Average mowing time, min	75	145	290	270
Average charging time, min	50	50	60	60

Boundary wire antenna	Automower® 420	Automower® 430X	Automower® 440	Automower® 450X
Operating Frequency Band, Hz	100-80000	100-80000	100-80000	100-80000
Maximum magnetic field ⁶ , dBuA/m	82	82	82	82
Maximum Radio-frequency power, mW @60m ⁷	<25	<25	<25	<25

Sound data ⁸	Automower® 420	Automower® 430X	Automower® 440	Automower® 450X
Sound level, perceived dB (A)	58	58	60	59
Measured sound power noise level, dB (A)	57	57	56	58
Noise emissions uncertainties, K _{WA} dB (A)	1	1	1	1
Guaranteed sound power noise level	58	58	56	59
Sound pressure noise level at the operator's ear, dB (A) ⁹	46	46	45	47

Mowing	Automower® 420	Automower® 430X	Automower® 440	Automower® 450X
Cutting system	3 pivoted cutting blades			
Cutting motor speed, rpm	2300	2300	2300	2300
Power consumption during cutting, W +/- 20 %	30	30	30	35
Cutting height, cm / in.	2-6 / 0.8-2.4	2-6 / 0.8-2.4	2-6 / 0.8-2.4	2-6 / 0.8-2.4
Cutting width, cm / in.	24 / 9.4	24 / 9.4	24 / 9.4	24 / 9.4
Narrowest possible passage, cm / in.	60 / 24	60 / 24	60 / 24	60 / 24
Maximum slope for work area, %	45	45	45	45
Maximum slope for boundary wire, %	15	15	15	15

⁵ XX, YY can be any alphanumeric characters or blank for marketing purpose only, no technical differences.

⁶ Measured according to EN 303 447.

⁷ Maximum active output power to antennas in the frequency band in which the radio equipment operates.

⁸ Determined according to Directive 2006/42/EC and standard EN 50636-2-107. Except Sound level, perceived that is measured according to ISO 11094:1991.

⁹ Sound pressure noise uncertainties K_{pA}, 2-4 dB (A)

Mowing	Automower® 420	Automower® 430X	Automower® 440	Automower® 450X
Maximum length boundary wire, m / ft.	800 / 2600	800 / 2600	800 / 2600	800 / 2600
Maximum length guide loop ¹⁰ , m / ft.	400 / 1300	400 / 1300	400 / 1300	400 / 1300
Maximum distance to boundary wire m / ft.	35 / 115	35 / 115	35 / 115	35 / 115
Area capacity, m ² / acre(s), +/- 20%	2200 / 0.55	3200 / 0.8	4000 / 1	5000 / 1.25

IP code	Automower® 420	Automower® 430X	Automower® 440	Automower® 450X
Robotic lawn mower	IPX4	IPX4	IPX4	IPX4
Charging station	IPX1	IPX1	IPX1	IPX1
Power supply	IP44	IP44	IP44	IP44

Frequency Band Support	
Automower® Connect 2G	GSM 850 MHz, E-GSM 900 MHz, DCS 1800 MHz, PCS 1900 MHz
Automower® Connect 3G	Band 19 (800 MHz), Band 5 (850 MHz), Band 8 (900 MHz), Band 2 (1900 MHz), Band 1 (2100 MHz)
Automower® Connect 4G	Band 12 (700 MHz), Band 17 (700 MHz), Band 28 (700 MHz), Band 13 (700 MHz), Band 20 (800 MHz), Band 26 (850 MHz), Band 5 (850 MHz), Band 19 (850 MHz), Band 8 (900 MHz), Band 4 (1700 MHz), Band 3 (1800 MHz), Band 2 (1900 MHz), Band 25 (1900 MHz), Band 1 (2100 MHz), Band 39 (1900 MHz)

Power Class		
Bluetooth® Output power	8 dBm	
Automower® Connect 2G	Power Class 4 (GSM/E-GSM)	33 dBm
	Power Class 1 (DCS/PCS)	30 dBm
	Power Class E2 (GSM/E-GSM)	27 dBm
	Power Class E2 (DCS/PCS)	26 dBm
Automower® Connect 3G	Power Class 3	24 dBm
Automower® Connect 4G	Power Class 3	23 dBm

Husqvarna AB does not guarantee full compatibility between the product and other types of wireless systems such as remote controls, radio transmitters, hearing loops, underground electric animal fencing or similar.

The products are made in England or the Czech Republic. See information on the rating plate. Refer to *Product overview on page 4*

8.2 Registered trademarks

The *Bluetooth®* word mark and logos are registered trademarks owned by *Bluetooth SIG, inc.* and any use of such marks by Husqvarna is under license.

¹⁰ The guide loop is the loop that is formed by the guide wire and the part of the boundary wire from the junction with the guide wire to the right connection in the charging station.

9 Warranty

9.1 Warranty terms

Husqvarna® warranty covers this product's functionality for a period of 2 years from date of purchase. The warranty covers serious faults relating to materials or manufacturing faults. Within the warranty period, we will replace the product or repair it at no charge if the following terms are met:

- The product and the charging station may only be used in compliance with the instructions in this Operator's Manual. This manufacturer's warranty does not affect warranty entitlements against the dealer/retailer.
- End-users or non-authorized third parties must not attempt to repair the product.

Examples of faults which are not included in the warranty:

- Damage caused by water seepage from using a high-pressure washer, or from being submerged under water, for example when heavy rain forms pools of water.
- Damage caused by lightning.
- Damage caused by improper battery storage or battery handling.
- Damage caused by using a battery that is not a Husqvarna original battery.
- Damage caused by not using Husqvarna original spare parts and accessories, such as blades and installation material.
- Damage to the loop wire.
- Damage caused by non-authorized changing or tampering with the product or its power supply.

The blades and wheels are seen as disposable and are not covered by the warranty.

If an error occurs with your Husqvarna product, please contact Husqvarna customer service for further instructions. Please have the receipt and the product's serial number at hand when contacting Husqvarna customer service.



Husqvarna[®]

AUTOMOWER[®] is a trademark owned by Husqvarna AB.
Copyright[®] 2022 HUSQVARNA. All rights reserved.

www.husqvarna.com

Original instructions

1142746-26



2022-03-18