



Operator's manual
HUSQVARNA AUTOMOWER®
305/310 Mark II/315 Mark II



EN, English

Read the operator's manual carefully and make sure that you understand the instructions before you use the product.

Contents

1 Introduction	
1.1 Introduction.....	3
1.2 Product overview	4
1.3 Symbols on the product.....	5
1.4 Symbols on the display.....	5
1.5 Symbols on the battery.....	6
1.6 General manual instructions.....	6
1.7 Menu structure overview - 1.....	7
1.8 Menu structure overview - 2.....	8
1.9 Display.....	9
1.10 Keypad.....	9
2 Safety	
2.1 Safety definitions.....	10
2.2 General safety instructions.....	10
2.3 Safety instructions for installation.....	11
2.4 Safety instructions for operation.....	11
2.5 Safety instructions for maintenance.....	11
2.6 Battery safety.....	11
2.7 How to lift and move the product.....	12
3 Installation	
3.1 Introduction - Installation.....	13
3.2 Main components for installation.....	13
3.3 General preparations.....	13
3.4 Before the installation of the wires.....	13
3.5 Installation of the product.....	18
3.6 To put the wire into position with stakes.....	19
3.7 To bury the boundary wire or the guide wire.....	20
3.8 To extend the boundary wire or the guide wire... ..	20
3.9 After the installation of the product.....	20
3.10 Product settings.....	21
3.11 Automower® Connect app.....	21
3.12 Product settings with keypad and display.....	21
4 Operation	
4.1 To use the ON/OFF button.....	31
4.2 To start the product.....	31
4.3 To park the product.....	31
4.4 To stop the product.....	32
4.5 To set the product to OFF.....	32
4.6 To charge the battery.....	32
4.7 Adjust the cutting height.....	32
5 Maintenance	
5.1 Introduction - maintenance.....	33
5.2 Clean the product.....	33
5.3 Replacement of the blades.....	34
5.4 Battery.....	35
5.5 Winter service.....	35
6 Troubleshooting	
6.1 Introduction - troubleshooting.....	36
6.2 Fault messages.....	36
6.3 Information messages.....	40
6.4 Indicator lamp in the charging station.....	41
6.5 Symptoms.....	42
6.6 Find breaks in the loop wire.....	43
7 Transportation, storage and disposal	
7.1 Transportation.....	46
7.2 Storage.....	46
7.3 Disposal.....	46
8 Technical data	
8.1 Technical data.....	47
8.2 Registered trademarks.....	49
9 Warranty	
9.1 Warranty terms.....	50

1 Introduction

1.1 Introduction

Serial number:
Product number:
PIN code:

The serial number and the product number are on the product rating plate and on the product carton.

- Register your product on www.husqvarna.com. Enter the serial number of the product, the product number and the date of purchase to register your product.

1.1.1 Support

For support about the product, speak to your Husqvarna servicing dealer.

1.1.2 Product description

Note: Husqvarna regularly updates the appearance and function of the products. Refer to *Support on page 3*.

The product is a robotic lawn mower. The product has a battery power source and cuts the grass automatically. It continuously alternates between mowing and charging. The movement pattern is random, which means that the lawn is mowed evenly and with less wear. The boundary wire and the guide wire controls the movement of the product within the work area. Sensors in the product senses when it is approaching the boundary wire. The front of the product always passes the boundary wire by a specific distance before the product turns around. When the product hits an obstacle or approaches the boundary wire the product selects a new direction.

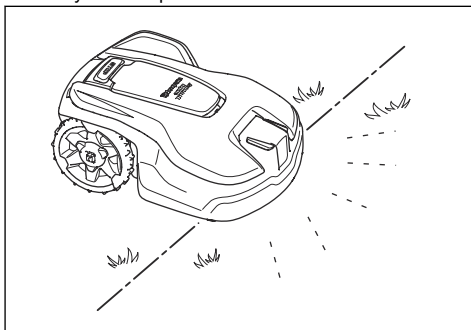

The operator selects the operation settings with the keys on the keypad. The display shows the selected and possible operation settings, and the operation mode of the product.

1.1.2.1 Mowing technique

The product is emission free, easy to use and saves energy. The frequent cutting technique improves the grass quality and decreases the use of fertilizers. Collection of grass is not necessary.

1.1.2.2 Find the charging station

The product operates until the battery state of charge is low, then the product starts to go to the charging station. The guide wire is put from the charging station to a remote part of the work area or through a narrow passage. The guide wire is connected with the boundary wire to make it easier and faster for the product to find the charging station.

1.1.2.3 Automower® Connect

Automower® Connect is a mobile application that makes it possible to select the operation settings remotely. Refer to *Automower® Connect app on page 21*.

1.2 Product overview

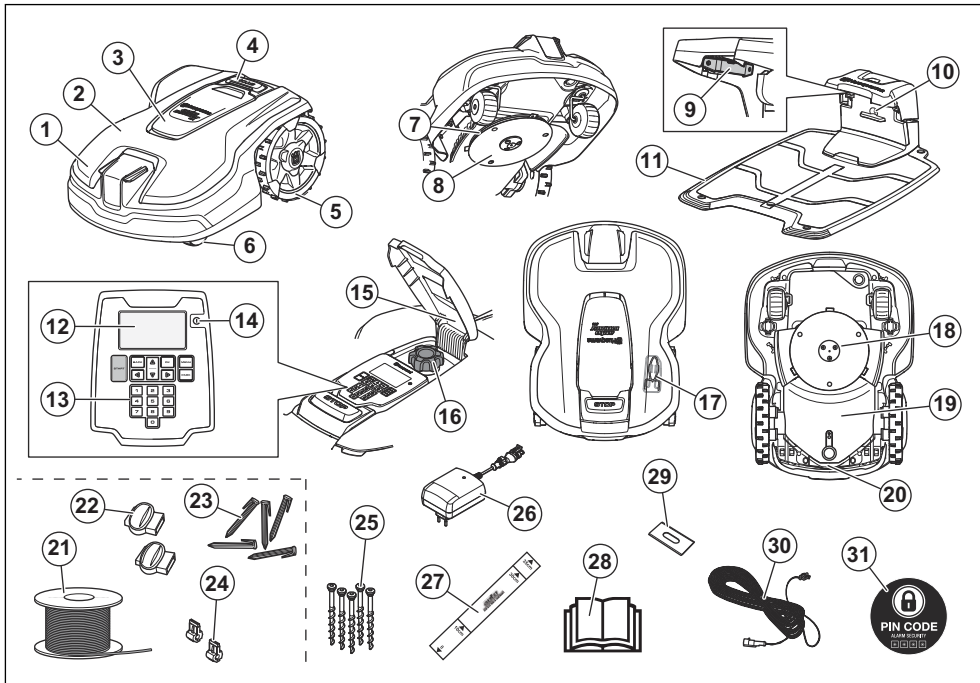

- | | |
|--|--|
| <ol style="list-style-type: none"> 1. Product body 2. Top cover 3. Hatch to keypad, display and cutting height adjustment 4. Stop button 5. Rear wheels 6. Front wheels 7. Blade disc 8. Skid plate 9. Contact plates 10. LED indicator for operation check of the charging station and boundary wire 11. Charging station 12. Display 13. Keypad 14. ON/OFF button 15. Rating plate with product identification code | <ol style="list-style-type: none"> 16. Cutting height adjustment 17. Maintenance tool¹ 18. Cutting system 19. Chassis box with electronics, battery and motors 20. Handle 21. Loop wire for boundary wire and guide wire² 22. Couplers for the loop wire³ 23. Stakes⁴ 24. Connectors for the loop wire⁵ 25. Screws to attach the charging station 26. Power supply⁶ 27. Measurement gauge for installation of the boundary wire (remove the measurement gauge from the carton of the product) 28. Operator's Manual and Quick Guide 29. Blade 30. Low-voltage cable |
|--|--|

¹ Found below the top cover.

² Is a part of the installation kit.

³ Is a part of the installation kit.

⁴ Is a part of the installation kit.

⁵ Is a part of the installation kit.

⁶ The appearance can be different for different markets.

1.3 Symbols on the product

These symbols can be found on the product. Study them carefully.



WARNING: Read the user instructions before operating the product.



WARNING: Disable the product before working on or lifting the product.



WARNING: Keep a safe distance from the product when operating. Keep your hands and feet away from the rotating blades.



WARNING: Do not ride on the product. Do not put your hands or feet close to or under the product.



Lock function.

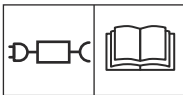

Use a detachable power supply as defined on the rating label next to the symbol.



This product conforms to the applicable EC Directives.



This product complies with the applicable UK Directives.



It is not permitted to dispose this product as normal household waste. Ensure that the product is recycled in accordance with local legal requirements.



The chassis contains components which are sensitive to electrostatic discharge (ESD). The chassis must also be resealed in a professional manner. For these reasons the chassis shall only be opened by authorized service technicians. A broken seal can result in the entire or parts of the guarantee no longer being valid.



The low-voltage cable must not be shortened, extended or spliced.

Do not use a trimmer nearby the low-voltage cable. Be careful when trimming edges where the cables are placed.

1.4 Symbols on the display



In the schedule menu you can set when the product will cut the lawn.



In the security menu you can select between 3 security levels for the product.



In the messages menu you can find the *Fault messages* and *Info messages* of the product.



The Weather timer function automatically adapts the cutting intervals to the grass growth.



In the installation menu you can set manual settings for the installation of the product.



In the settings menu you can set the general settings of the product.



In the accessories menu you can set the settings for the accessories of the product.



The schedule is set for the product to not cut the grass.



The product overrides the schedule.



The battery indicator shows the charge level of the battery. When the product charges the symbol flashes.



The product is in the charging station and the battery is fully charged.



The product is set in ECO-mode.



Bluetooth® wireless communication with Automower® Connect on your mobile device.

1.5 Symbols on the battery



WARNING: Lithium-ion batteries can explode or cause fire if disassembled, short-circuited or handled roughly. Do not expose to water, fire or high temperature.



Read the user instructions.



Do not discard the battery into fire and do not expose the battery to a heat source.



Do not immerse the battery into water.

1.6 General manual instructions

The following system is used in the Operator's Manual to make it easier to use:

- Text written in *italics* is a text that is shown in the display or is a reference to another section in the Operator's Manual.
- Text written in **bold** is one of the buttons on the product.

1.7 Menu structure overview - 1

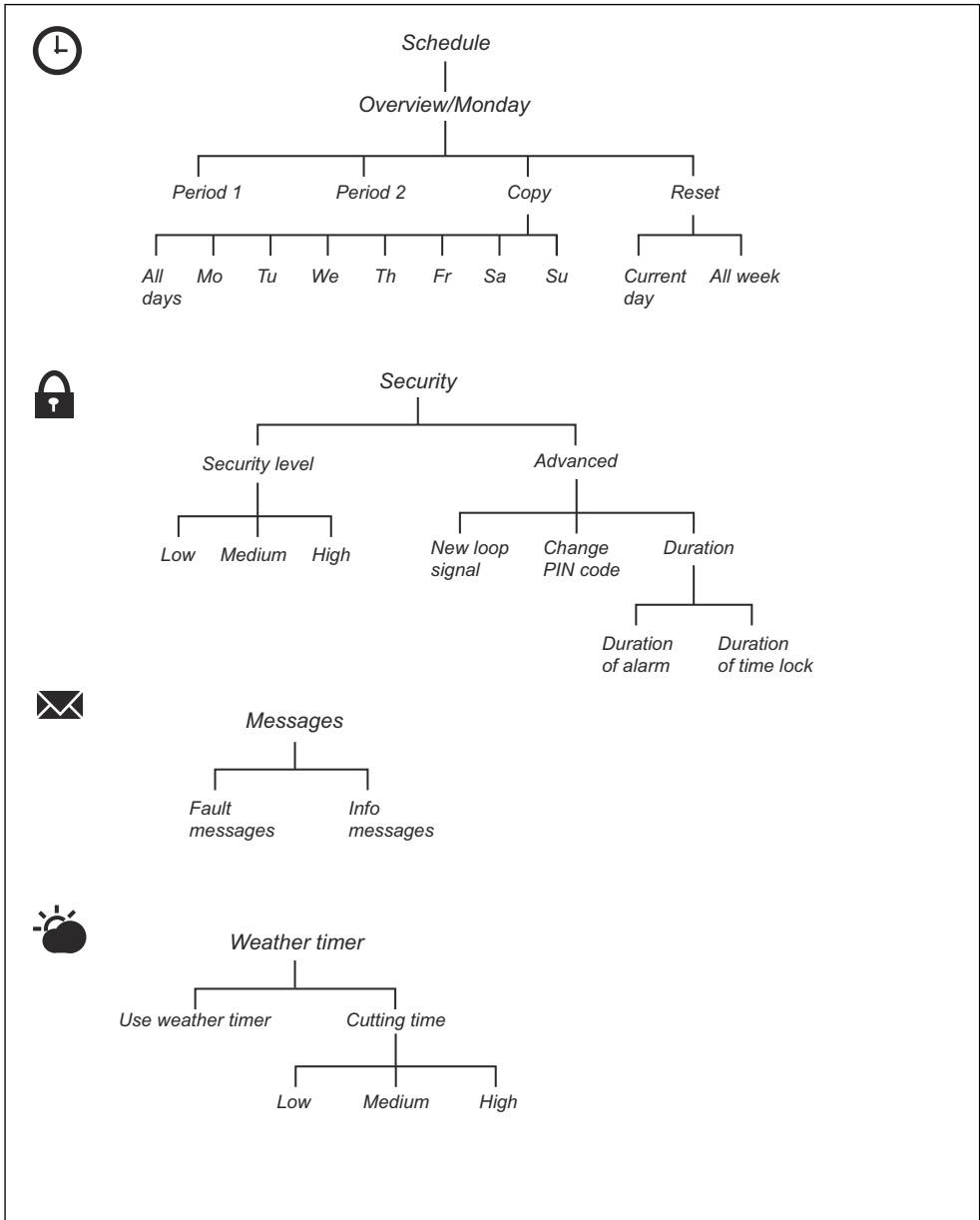

1.8 Menu structure overview - 2

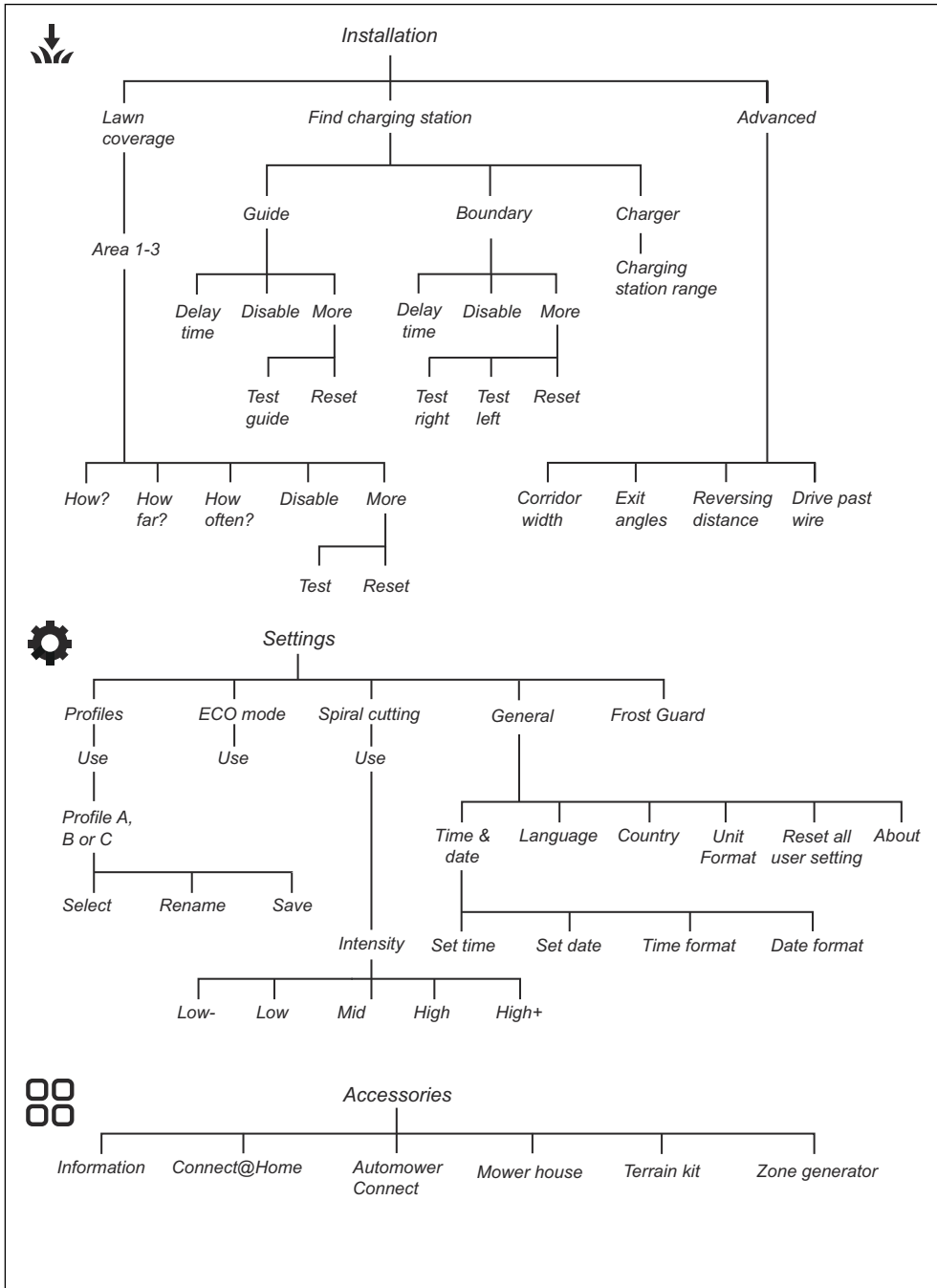

1.9 Display

The display on the product shows information and settings of the product.

To access the display, push the **STOP** button.

1.10 Keypad

Use the keypad on the product to move around in the menu structure. To get access to the keypad, push the **STOP** button.

- Use the **ON/OFF** button (A) to set the product to ON or OFF. The LED indicator on the keypad shows if the product is ON or OFF. Refer to *To use the ON/OFF button on page 31*.
- Use the **START** button (B) to start the operation of the product.
- Use the **BACK** button (C) to move up in the menu lists.
- Use the **arrow** buttons (D) to move around in the menu.
- Use the **OK** button (E) to do selections.
- Use the **MENU** button (F) to go to the main menu.
- Use the **PARK** button (G) to send the product to the charging station.
- Use the **number** buttons (H) to enter digits.

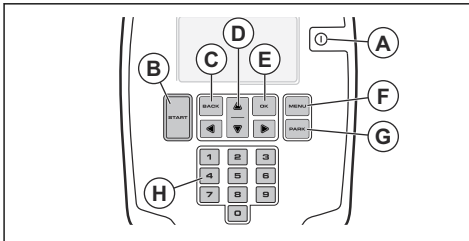

2 Safety

2.1 Safety definitions

Warnings, cautions and notes are used to point out specially important parts of the manual.



WARNING: Used if there is a risk of injury or death for the operator or bystanders if the instructions in the manual are not obeyed.



CAUTION: Used if there is a risk of damage to the product, other materials or the adjacent area if the instructions in the manual are not obeyed.

Note: Used to give more information that is necessary in a given situation.

2.2 General safety instructions



WARNING: Read the warning instructions that follow before you use the product.

- Read the Operator's manual carefully and make sure you understand the instructions before you use the product. Keep for future reference.
 - This appliance is not intended for use by children or persons with reduced physical, sensory or mental capabilities (that could affect a safe handling of the product), or lack of experience and knowledge, unless they have been given supervision or instruction concerning use of the appliance by a person responsible for their safety. However, EU requirements allows this appliance to be used by children aged from 8 years and above and persons with reduced physical, sensory or mental capabilities or lack of experience and knowledge, if they have been given supervision or instruction concerning use of the appliance in a safe way and understand the hazards involved. Children shall not play with the appliance. Cleaning and user maintenance shall not be made by children without supervision.
 - The product must only be used with the equipment recommended by Husqvarna. All other types of use are incorrect.
 - Do not use the product when persons, especially children, or animals are in the work area.
 - Warning signs must be put around the work area of the product if it operates in public areas. The signs must have the text that follows: Warning!
- Automatic lawn mower! Keep away from the machine! Supervise children!
- Do not touch moving hazardous parts, such as the blade disc, before it has come to a complete stop.
 - Set the product to OFF before you clear a blockage, do maintenance or examine the product, and if the product starts to vibrate abnormally. Examine the product for damage before you start the product again. Do not use the product to it is defective.
 - If an injury or accident occur, get medical aid.
 - Do not put power supply cable and extension cable in the work area. This can cause damage to the cables.
 - Do not connect a damaged cable or plug, or touch a damaged cable, before it is disconnected from the power outlet. Disconnect the plug from the power outlet if the cable becomes damaged while in operation. A worn or damaged cable increases the risk of electrical shock. A damaged cable must be replaced by service personnel.
 - When you connect the power supply to the power outlet, use a residual-current device (RCD) with a tripping current of maximum 30 mA.
 - Only charge the product in the included charging station. For safe disposal of the battery, refer to *Disposal on page 46*. Incorrect use may result in electric shock, overheating or leaking of corrosive liquid from the battery. In the event of leakage of electrolyte, flush with water/neutralizing agent. Get medical aid if corrosive liquid comes in your eyes.
 - Use only original batteries recommended by Husqvarna. Product safety cannot be guaranteed with other than original batteries. Do not use non-rechargeable batteries.
 - Follow the installation instructions that includes to specify the work area, refer to *Installation of the product on page 18*.
 - Follow the instructions about to start and operate the product, refer to *Operation on page 31*.
 - If there is a risk of thunderstorm, Husqvarna recommends that the power supply and all the wires to the charging station are disconnected to decrease the risk of damage to electrical components. Connect the power supply and all the wires again if there is no longer a risk of thunderstorm. It is important that all wires are connected correctly.
 - Follow the maintenance instructions and if necessary use Husqvarna original spare parts, refer to *Maintenance on page 33*.
 - For technical data such as weight, dimensions and noise emission values, refer to *Technical data on page 47*.
 - The operator is responsible for accidents or dangers that occurs to other persons or property.

- The product must only be operated, maintained and repaired by persons that are fully conversant with its special characteristics and safety regulations.
- It is not permitted to change the initial design of the product.
- Obey national regulations about electrical safety.
- Husqvarna does not guarantee full compatibility between the product and other types of wireless systems such as remote controls, radio transmitters or equivalent.
- The built-in alarm is very loud. Be careful, especially if the product is handled indoors.
- Operation and storage temperature range is 0-50 °C / 32-122 °F. Temperature range for charging is 0-45 °C / 32-113 °F. Too high temperatures can cause damage to the product.

2.3 Safety instructions for installation



WARNING: Read the warning instructions that follow before you use the product.

- Do not install the charging station, including any accessory, at a location that is below, or within 60 cm / 24 in. from, any combustible material. In case of malfunction, heating of the charging station and the power supply may occur and create a potential risk of fire.
- Do not put the power supply at a height where there is a risk it can be put in water. Do not put the power supply on the ground.
- Do not encapsulate the power supply. Condensed water can harm the power supply and increase the risk of electrical shock.
- Applicable to USA/Canada. If power supply is installed outdoors: Risk of Electric Shock. Install only to a covered Class A GFCI receptacle (RCD) that has an enclosure that is weatherproof with the attachment plug cap inserted or removed.

2.4 Safety instructions for operation



WARNING: Read the warning instructions that follow before you use the product.

- Keep your hands and feet away from the rotating blades. Do not put your hands or feet near or below the product when it is set to ON.
- Use the park mode or set the product to OFF when persons, especially children or animals are in the work area. Refer to *To set the product to OFF on page 32*. Husqvarna recommends to set the product to operate when the work area has no activity. The product can cause injury to animals at

night in work area, for example hedgehogs. Refer to *Schedule on page 22*.

- Make sure that there are no objects such as stones, branches, tools or toys on the lawn. The blades can be damaged if it hits an object.
- Do not lift the product or move it when it is set to ON.
- Do not let the product collide with persons or animals. If a person or animal comes in the way of the product, stop the product immediately. Refer to *To stop the product on page 32*.
- Do not put objects on top of the product or its charging station.
- Do not use the product if the **STOP** button does not work.
- Always set the product to OFF when it is not in operation. The product can only start when you enter the correct PIN code.
- Do not use the product at the same time as a pop-up sprinkler. Use the *Schedule* function so the product and pop-up sprinkler do not operate at the same time. Refer to *To set the schedule on page 22*.

2.5 Safety instructions for maintenance



WARNING: Read the warning instructions that follow before you do maintenance on the product.

- Set the product to **OFF** when you do maintenance on the product.
- Do not use a high-pressure washer to clean the product. Do not use solvents to clean the product.
- Disconnect the plug to the charging station before you clean or do maintenance of the charging station.

2.6 Battery safety



WARNING: Read the warning instructions that follow before you use the product.

- Lithium-ion batteries can explode or cause fire if disassembled, short-circuited, exposed to water, fire, or high temperatures. Handle carefully, do not dismantle, open the battery or use any type of electrical/mechanical abuse. Avoid storage in direct sunlight.

2.7 How to lift and move the product



WARNING: The product must be switched off before lifting it. The product is disabled when the indicator lamp on the keypad is not lit.



CAUTION: Do not lift the product when it is parked in the charging station. It can damage the charging station and/or the product. Push **STOP** and pull the product out of the charging station before lifting it.

To safely move from or within the work area:

1. Push the **STOP** button to stop the product.

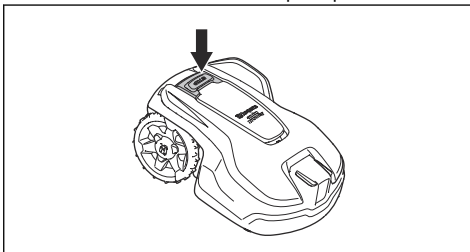

2. Push the **ON/OFF** button for 3 seconds and make sure the product is switched off. Check that the indicator lamp on the keypad is not lit. This means that the product is disabled. Refer to *To use the ON/OFF button on page 31*.

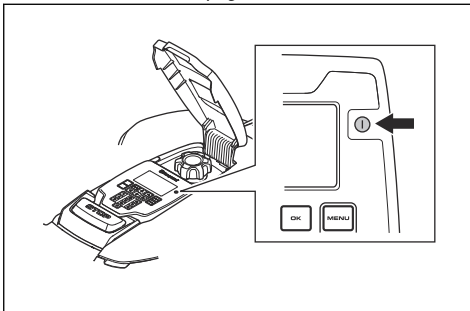

3. Carry the product by the handle with the blade disc away from the body.



3 Installation

3.1 Introduction - Installation



WARNING: Read and understand the safety chapter before you install the product.



CAUTION: Use original spare parts and installation material.

Note: Refer to www.husqvarna.com for more information about installation.

3.2 Main components for installation

The installation involves the following components:

- A robotic lawn mower that mows the lawn automatically.
- A charging station, which has 3 functions:
 - To send control signals along the boundary wire.
 - To send control signals along the guide wire so that the product can follow the guide wire to specific remote areas in the garden and can find its way back to the charging station.
 - To charge the product.
- A power supply, which is connected to the charging station and a 100-240V power outlet.
- Loop wire, which is laid around the work area and around objects and plants that the product must not run into. The loop wire is used both as boundary wire and guide wire.

3.3 General preparations



CAUTION: Holes with water in the lawn can cause damage to the product.

Note: Read through the Installation chapter before beginning the installation. How the installation is done affects how the product performs. It is therefore important to plan the installation carefully.

- Make a blueprint of the work area and include all obstacles. This makes it easier to see the ideal positions for the charging station, the boundary wire and the guide wire.
- Make a mark on the blueprint where to put the charging station, the boundary wire and the guide wire.

- Make a mark on the blueprint where the guide wire connects to the boundary wire. Refer to *To install the guide wire on page 19*.
 - Fill in holes in the lawn.
 - Cut the grass before you install the product. Make sure that the grass is maximum 10 cm / 3.9 in.
-

Note: The first weeks after installation the perceived sound level when cutting the grass may be higher than expected. When the product has cut the grass for some time, the perceived sound level is much lower.

3.4 Before the installation of the wires

You can select to attach the wires with stakes or bury them. You can use the 2 procedures for the same work area.



CAUTION: If you use a dethatcher in the work area, bury the boundary wire and the guide wire to prevent them from damage.

3.4.1 To examine where to put the charging station

- Keep a minimum 3 m / 10 ft. of free space in front of the charging station. Refer to *To examine where to put the guide wire on page 17*.
- Keep a minimum of 150 cm / 60 in. of free space to the right and left of the center of the charging station.
- Put the charging station near a power outlet.
- Put the charging station on a level surface.
- The baseplate of the charging station must not be bent.

max. 5 cm / 2"

max. 5 cm / 2"



- If the work area has two parts separated with a steep slope, we recommend to put the charging station in the lower section.

- Put the charging station in an area with protection from the sun.
- If the charging station is installed on an island, make sure to connect the guide wire to the island. Refer to *To make an island on page 16.*

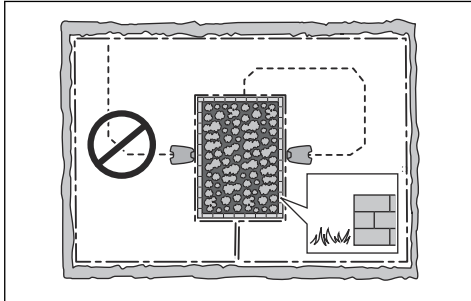

3.4.2 To examine where to put the power supply



WARNING: Do not cut or extend the low-voltage cable. There is a risk of electrical shock.



CAUTION: Make sure that the blades on the product do not cut the low-voltage cable.



WARNING: The power supply cable and extension cable must be outside the work area to avoid damage to the cables.



CAUTION: Do not put the low-voltage cable in a coil or below the charging station plate. The coil causes interference with the signal from the charging station.



- Put the power supply in an area with a roof and protection from the sun and rain.
- Put the power supply in an area with good airflow.
- Use a residual-current device (RCD) with a tripping current of maximum 30 mA when you connect the power supply to the power outlet.

Low-voltage cables of different lengths are available as accessories.

3.4.3 To examine where to put the boundary wire



CAUTION: There must be a barrier of minimum 15 cm / 6 in. in height between the boundary wire and water bodies, slopes, precipices or public roads. This will prevent damage to the product.



CAUTION: Do not let the product operate on gravel.



CAUTION: Do not make sharp bends when you install the boundary wire.



CAUTION: For careful operation without noise, isolate all obstacles such as trees, roots and stones.

The boundary wire should be put as a loop around the work area. Sensors in the product senses when the product approaches the boundary wire, and the product selects another direction. All parts of the work area must be maximum 35 m / 115 ft. from the boundary wire.

To make the connection easier between the guide wire and the boundary wire, it is recommended to make an eyelet where the guide wire will be connected. Make the eyelet with approximately 20 cm / 8 in. of the boundary wire.

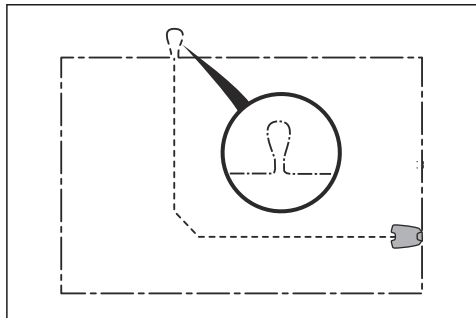

Note: Make a blueprint of the work area before you install the boundary wire and guide wire.

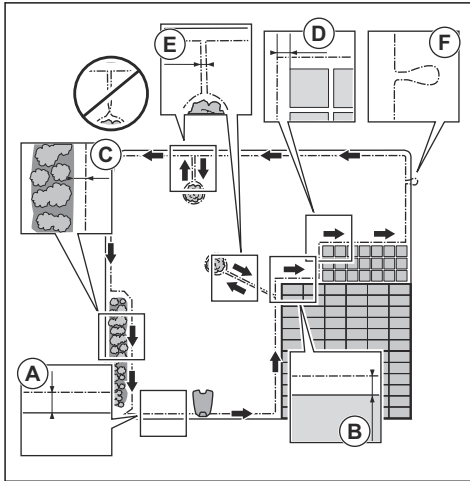

- Put the boundary wire around all of the work area (A). Adapt the distance between the boundary wire and obstacles.
- Put the boundary wire 35 cm / 14 in. (B) from an obstacle that is more than 5 cm / 2 in. high.

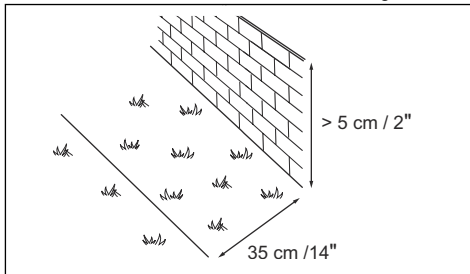

- Put the boundary wire 30 cm / 12 in. (C) from an obstacle that is 1-5 cm / 0.4-2 in. high.

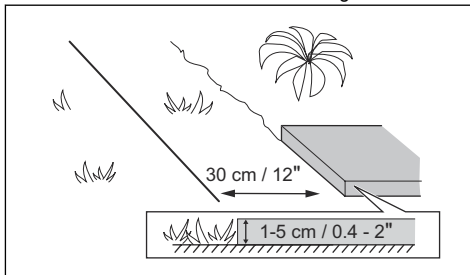

- Put the boundary wire 10 cm / 4 in. (D) from an obstacle that is less than 1 cm / 0.4 in. high.

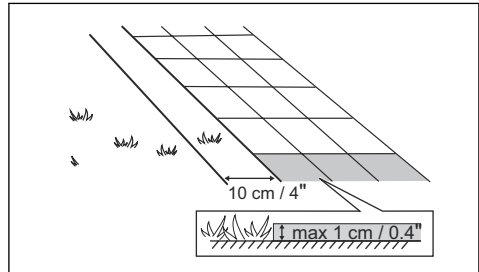

- If you have a paving stone path that is in level with the lawn, put the boundary wire below the paving stone.

Note: If the paving stone is minimum 30 cm / 12 in. wide, use the factory setting for the *Drive Past Wire* function to cut all the grass adjacent to the paving stone. Refer to *To set the Drive Past Wire function on page 27.*

- If you make an island, put the boundary wire that runs to and from the island near together (E). Put the wires in the same stake. Refer to *To make an island on page 16.*
- Make an eyelet (F) where the guide wire is to be connected to the boundary wire.

3.4.3.1 To put the boundary wire in a slope

The product can operate in 40% slopes. Slopes that are too steep must be isolated with the boundary wire. The gradient (%) is calculated as height per m. Example: 10 cm / 100 cm = 10%.

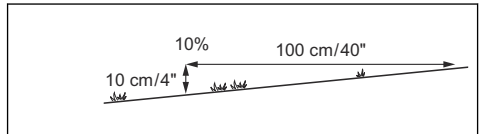

- For slopes steeper than 40% inside the work area, isolate the slope with boundary wire.
- For slopes steeper than 15% along the outer edge of the lawn, put the boundary wire 20 cm / 8 in. (A) from the edge.

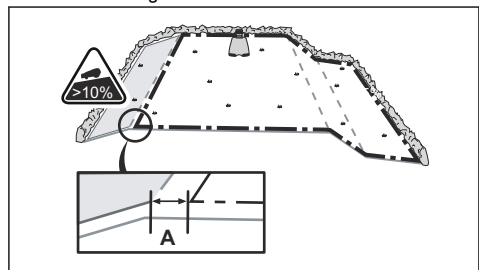

- For slopes adjacent to a public road, put a barrier of minimum 15 cm / 6 in. along the outer edge of

the slope. You can use a wall or a fence as a barrier.

3.4.3.2 Passages

A passage is a section that has boundary wire on each side and that connects 2 parts of the work area. The distance between the boundary wire on each side in the passage must be a minimum of 60 cm / 24 in.

Note: If a passage is less than 2 m / 6.5 ft. wide, install a guide wire through the passage.

The recommended minimum distance between the guide wire and the boundary wire is 30 cm / 12 in. The product always runs to the left of the guide wire as seen facing the charging station. It is recommended to have as much free area as possible to the left of the guide wire (A).

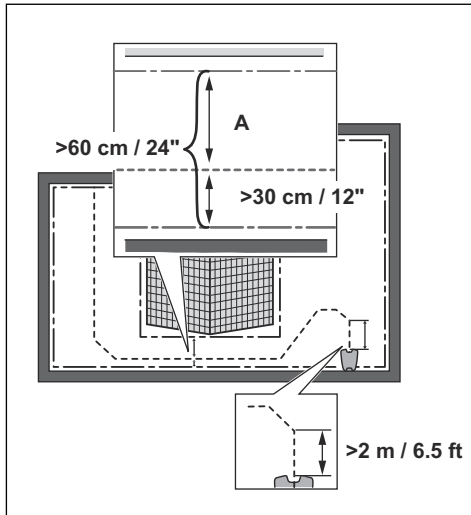

3.4.3.3 To make an island



CAUTION: Do not put a section of boundary wire across the other. The sections of boundary wire must be parallel.



CAUTION: Do not put the guide wire across the boundary wire.



CAUTION: Isolate or remove obstacles that are less than 15 cm / 6 in. in height. Isolate or remove obstacles that slope slightly, for example, stones, trees or roots.

This will prevent damage to the blades of the product.

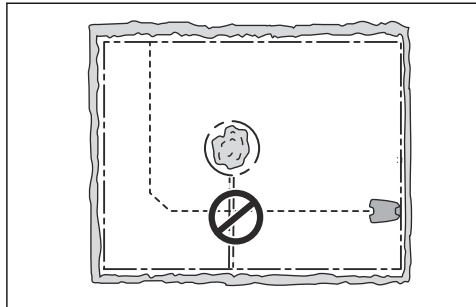

To make an island, isolate areas in the work area with the boundary wire. We recommend to isolate all stable objects in the work area.

Some obstacles are resistant to a collision, for example, trees or bushes that are more than 15 cm / 6 in. in height. The product will collide with the obstacle and then select a new direction.

- Put the boundary wire to and around the obstacle to make an island.
- Put the 2 sections of boundary wire to and from the island close together. This will make the product run across the wire.
- Put the 2 sections of boundary wire in the same stake.

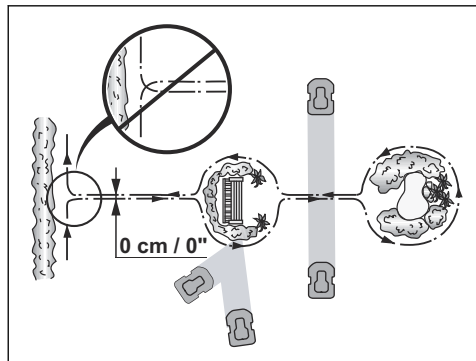

3.4.3.4 To make a secondary area

Make a secondary area (B) if the work area has 2 areas that are not connected with a passage. The work area with the charging station is the main area (A).

Note: The product must be manually moved between the main area and the secondary area.

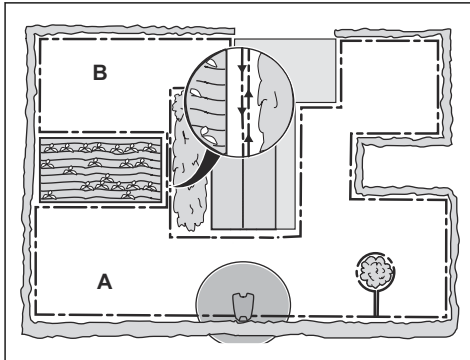

- Put the boundary wire around the secondary area (B) to make an island. Refer to *To make an island on page 16*.

Note: The boundary wire must be put as 1 loop around all of the work area (A + B).

Note: When the product cuts grass in the secondary area, the *Secondary area mode* must be selected. Refer to *Secondary area on page 31*.

3.4.4 To examine where to put the guide wire

- Put the guide wire in a line at a minimum of 2 m / 6.5 ft. in front of the charging station.
- Make as much free area as possible to the left of the guide wire when facing the charging station. Refer to *Corridor width on page 26*.
- Put the guide wire minimum 30 cm / 12 in. from the boundary wire.
- Do not make sharp bends when you install the guide wire.

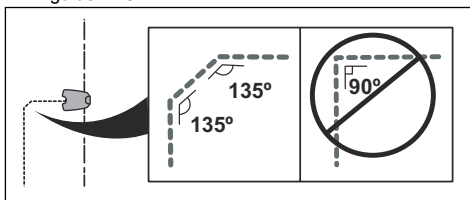

- If the work area has a slope, put the guide wire diagonally across the slope.

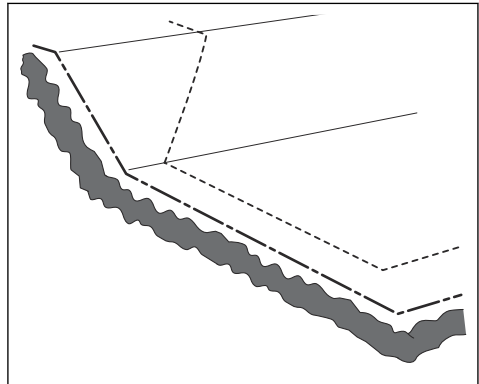

3.4.5 Work area examples

- If the charging station is put in a small area (A), make sure that the distance to the boundary wire is at a minimum 3 m / 10 ft. in front of the charging station.
- If the work area has a passage (B) with no guide wire installed, the minimum distance between the boundary wires is 2 m / 6.5 ft. With a guide wire installed through the passage, the minimum distance between the boundary wires is 60 cm / 24 in.
- If the work area has areas which are connected by a narrow passage (B), you can set the product to first follow and then leave the guide wire after a certain distance (C). The settings can be changed in *Lawn Coverage and Systematic Passage Mowing on page 24*.
- If the work area includes a secondary area (D), refer to *Secondary area on page 31*. Put the product in the secondary area and select *Secondary area mode*.

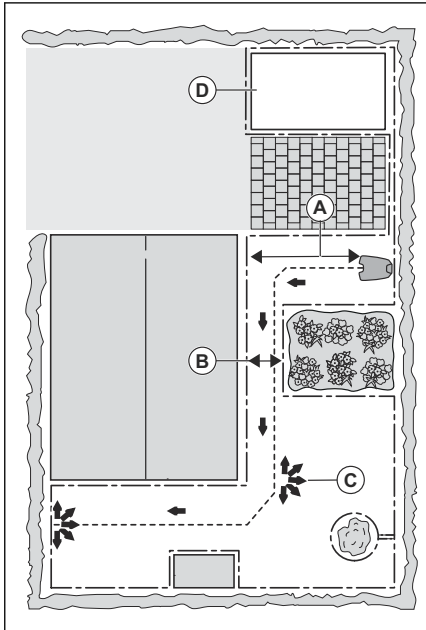

1. Read and understand the instructions about where to put the charging station. Refer to *To examine where to put the charging station on page 13*.
2. Put the charging station in the selected area.

Note: Do not attach the charging station with the screws to the ground until the guide wire is installed. Refer to *To install the guide wire on page 19*.

3. Connect the low-voltage cable to the charging station.
4. Put the power supply at a minimum height of 30 cm / 12 in.

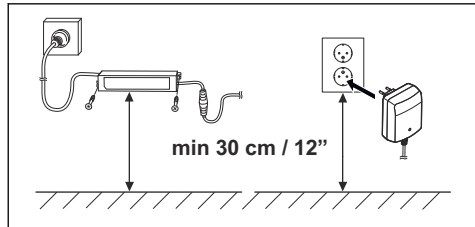

5. Connect the power supply cable to a 100-240V power outlet.

Note: When the charging station is connected, it is possible to charge the product. Put the product in the charging station while the boundary and guide wires are being laid. Switch on the product to start charging the product. Refer to *To use the ON/OFF button on page 31*. Do not continue with any product settings before the installation is complete.

6. Put the low-voltage cable in the ground with stakes or bury the cable. Refer to *To put the wire into position with stakes on page 19* or *To bury the boundary wire or the guide wire on page 20*.
7. Connect the wires to the charging station after the installation of boundary wire and guide wire is complete. Refer to *To install the boundary wire on page 18* and *To install the guide wire on page 19*.
8. Attach the charging station to the ground with the supplied screws after the guide wire is installed. Refer to *To install the guide wire on page 19*.

3.5.3 To install the boundary wire

CAUTION: Do not put remaining wire in a coil. The coil causes interference with the product.

1. Put the boundary wire around all of the work area. Start and complete the installation behind the charging station.

3.5 Installation of the product

3.5.1 Installation tools

- Hammer/plastic mallet: To simplify putting the stakes into the ground.
- Edge cutter/straight spade: To bury the boundary wire.
- Combination pliers: For cutting the boundary wire and pressing the connectors together.
- Adjustable plier: For pressing the couplers together.

3.5.2 To install the charging station



CAUTION: Do not make new holes in the charging station plate.



CAUTION: Do not put your feet on the baseplate of the charging station.



WARNING: Make sure that the plugs of the low-voltage cable and the power supply unit are clean and dry before you connect them.

- Open the connector and put the boundary wire in the connector.

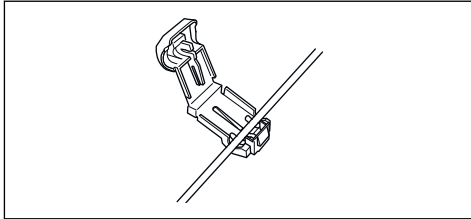

- Close the connector with a pair of pliers.

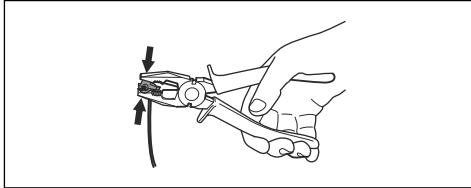

- Cut the boundary wire 1-2 cm / 0.4-0.8 in. above each connector.
- Push the right connector onto the metal pin on the charging station with the mark "AR".
- Push the left connector onto the metal pin on the charging station with the mark "AL".

3.5.4 To install the guide wire



CAUTION: Twinned cables, or a screw terminal block that is insulated with insulation tape are not satisfactory splices. Soil moisture will cause the wire to oxidize and after a time result in a broken circuit.

- Open the connector and put the wire in the connector.
- Close the connector with a pair of pliers.
- Cut the guide wire 1-2 cm / 0.4-0.8 in. above each connector.
- Push the guide wire through the slot in the charging station plate.
- Push the connector onto the metal pin on the charging station with the mark "GUIDE".
- Disconnect the charging station from the power outlet.
- Put the end of the guide wire at the eyelet on the boundary wire.
- Cut the boundary wire with a pair of wire cutters.
- Connect the guide wire to the boundary wire with a coupler.

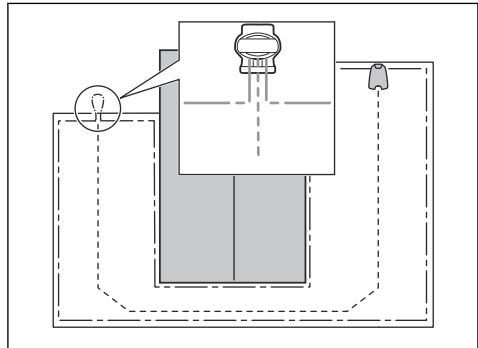

- Put the 2 ends of the boundary wire and the end of the guide wire into the coupler.

Note: Make sure that you can see the ends of the wires through the transparent area of the coupler.

- Push down the cover on the coupler with adjustable pliers to attach the wires in the coupler.

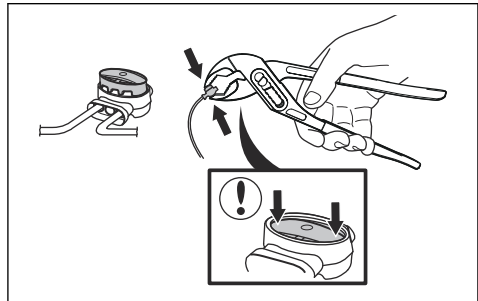

- Attach the guide wire to the ground with stakes or bury the guide wire in the ground. Refer to *To put the wire into position with stakes on page 19* or *To bury the boundary wire or the guide wire on page 20*.
- Connect the charging station to the power outlet.

3.6 To put the wire into position with stakes



CAUTION: Make sure that the stakes hold the boundary wire and the guide wire against the ground.



CAUTION: Cutting the grass too low right after installation can damage the wire insulation. Damage to the insulation may not cause disruptions until several weeks or months later.

1. Put the boundary wire and the guide wire on the ground.
2. Put the stakes at a maximum of 75 cm / 30 in. distance from each other.
3. Attach the stakes to the ground with a hammer or a plastic mallet.

Note: The wire is overgrown with grass and not visible after a few weeks.

3.7 To bury the boundary wire or the guide wire

- Cut a groove in the ground with an edge cutter or a straight shovel.
- Put the boundary wire or the guide wire 1-20 cm / 0.4-8 in. into the ground.

3.8 To extend the boundary wire or the guide wire

Note: Extend the boundary wire or the guide wire if it is too short for the work area. Use original spare parts, for example couplers.

1. Disconnect the charging station from the power outlet.
2. Cut the boundary wire or the guide wire with a pair of wire cutters where it is necessary to install the extension.
3. Add wire where it is necessary to install the extension.
4. Put the boundary wire or the guide wire into position.
5. Put the wire ends into a coupler.

Note: Make sure that you can see the ends of the boundary wire or the guide wire through the transparent area of the coupler.

6. Push down the cover on the coupler with adjustable pliers to attach the wires in the coupler.

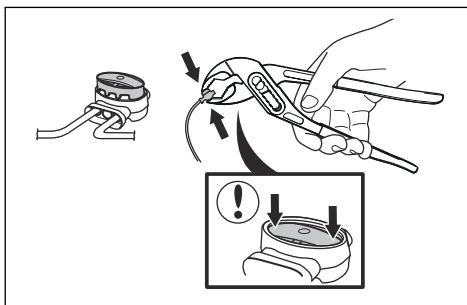

7. Put the boundary wire or the guide wire into position with stakes.
8. Connect the charging station to the power outlet.

3.9 After the installation of the product

3.9.1 To do a visual check of the charging station

1. Make sure that the indicator LED lamp on the charging station has a green light.

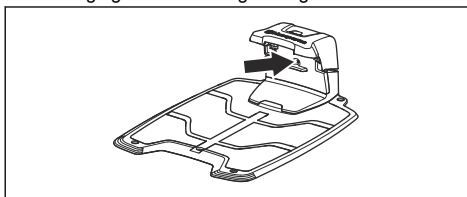

2. If the indicator LED lamp does not have a green light, do a check of the installation. Refer to *Indicator lamp in the charging station on page 41* and *To install the charging station on page 18*.

3.9.2 To do the basic settings

Before the product starts to operate for the first time, you must do the basic settings.

1. Put the product in the charging station.
2. Switch on the product.
3. Push the **arrow** buttons and the **OK** button. Select language, country, date, time and set a PIN code.

Note: For some models, a factory PIN code is necessary before you select a personal PIN code. It is not possible to use 0000 as PIN code.

4. Push the **Start** button and close the hatch to initiate a calibration process of the product.

Note: If the battery is too low, the product needs to charge the batteries fully before the calibration starts. Refer to *Calibration on page 21*.

Note: Make a note of the PIN code. Refer to *Introduction on page 3*.

3.9.3 Calibration

The calibration process is automatic. After the basic settings are done, the product moves away from the charging station and stops, while it calibrates some of the product settings. When the calibration is complete, the product starts to mow.

3.10 Product settings

You can use the keypad and the display on the product or the Automower® Connect app to do the settings for the functions of the product. The functions of the product have factory settings that are applicable for almost all work areas, but the settings can be adapted to the conditions for each work area.

3.11 Automower® Connect app

The product can connect to mobile devices that have the Automower® Connect app installed. Automower® Connect is a free app for your mobile device. You can use the extended functions for the product in the Automower® Connect app.

- The *Dashboard* shows the current operation of the product. You can select an operating mode for the product in the dashboard.
- The *Map* shows the current position of the product and the set center point for the GeoFence function.
- In the *Settings* menu you can set the settings for the product.
- In the *Statistics* menu you can see the statistics of the product.
- In the *Messages* menu you can find the *Fault messages* and the *Information messages* of the product.

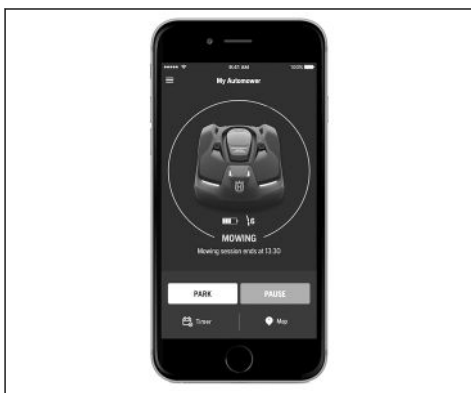

The Automower® Connect app has Long-range cellular connectivity and Short-range Bluetooth® connectivity.

3.11.1 To install the Automower® Connect app

1. Download the Automower® Connect app on your mobile device.
2. Sign up for a Husqvarna account in the Automower® Connect app.
3. An e-mail is sent to the registered e-mail address. Follow the instructions in the e-mail in less than 24 hours to validate your account.
4. Log in to your Husqvarna account in the Automower® Connect app.

3.11.2 To pair Automower® Connect@Home and the product

Automower® Connect@Home function with Bluetooth® communication is included in Automower® 305 / 310 Mark II / 315 Mark II. This means that the mobile device can communicate with the product while you are in Bluetooth® communication range.

1. Do steps 1–3 in *To get access to the menu in the display of the product on page 21*.
2. Use the **arrow** buttons and the **OK** button to move through the menu structure *Accessories > Connect@Home > Pairing > New pairing*.
3. Follow the instructions in the Automower® Connect app.

3.12 Product settings with keypad and display

3.12.1 To get access to the menu in the display of the product

1. Push the **STOP** button.
2. Use the **number** buttons and the **OK** button to enter the PIN code.
3. Push the **MENU** button.

3.12.2 Menu structure

The main menu contains:

- *Schedule*
- *Security*
- *Messages*
- *Weather timer*
- *Installation*
- *Settings*
- *Accessories*

Refer to *Menu structure overview - 1 on page 7* and *Menu structure overview - 2 on page 8*.

3.12.3 Schedule



Note: The lawn should not be cut too often to obtain the best result. If the product is allowed to operate too much, the lawn may appear flattened. The product is also subjected to unnecessary wear.

3.12.3.1 To set the schedule

- Do steps 1–3 in *To get access to the menu in the display of the product on page 21*.
- Use the **arrow** buttons and the **OK** button to move through the menu structure *Schedule > Overview*.
- Use the **arrow** buttons and the **OK** button to select the day.
- Use the right **arrow** button to select the period.
- Push the **OK** button.
- Calculate the suitable operating hours. Refer to *Make an estimate of the necessary operating time on page 22*.
- Enter the time with the **number** buttons. The product can cut the grass 1 or 2 periods each day.

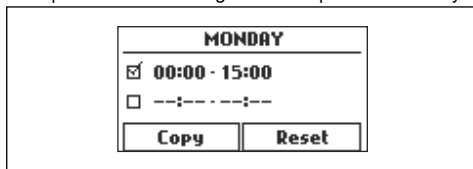

- If the product must not cut grass on a specified day, unselect the box adjacent to the 2 time periods.

3.12.3.2 Make an estimate of the necessary operating time

If the work area is less than maximum product capacity, the schedule must be set to decrease the wear on the lawn and the product. The product has a maximum cutting time each day. You can set the operating time of the product in the schedule. The operating time includes cutting, searching and charging. The operating time can be different because of many reasons, for example the layout of the work area, the grass growth and age of the battery. When the product has operated to the maximum cutting time in a day, the message *Today's mowing complete* is shown in the display of the app.

The recommended operating times for some work area examples are shown in the table below. If the result is not satisfactory, increase the operating time.

Area, m ²	Recommended operating time, h
300	4-5
600	9-10

3.12.3.3 To copy the schedule setting

- Do steps 1–3 in *To get access to the menu in the display of the product on page 21*.
- Use the **arrow** buttons and the **OK** button to move through the menu structure *Schedule > Overview > Copy*.
- Use the **arrow** buttons and the **OK** button to copy the schedule setting. You can copy the schedule settings day to day or for the full week.

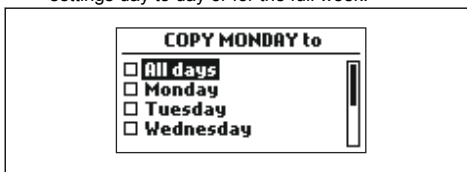

3.12.3.4 To reset the schedule setting

You can remove all schedule settings and use the factory setting.

- Do steps 1–3 in *To get access to the menu in the display of the product on page 21*.
- Use the **arrow** buttons and the **OK** button to move through the menu structure *Schedule > Overview > Reset*.
 - Push the **arrow** buttons to select *Current day* to only reset the current day to factory settings.
 - Push the **arrow** buttons to select *All week* to reset all schedule settings to factory settings.
- Push the **OK** button.

3.12.4 Security level



There are 3 security levels for the product.

Function	Low	Medium	High
Alarm			X
PIN-code		X	X
Time lock	X	X	X

- Alarm** - An alarm goes off if the PIN-code is not entered within 10 seconds after the **STOP** button is pushed. The alarm also goes off when the product

is lifted. The alarm stops when the PIN-code is entered.

- **PIN-code** - The correct PIN-code must be entered to get access to the Menu structure of the product. If the incorrect PIN-code is entered 5 times, the product is locked for a time. The lock is extended for each new incorrect try.
- **Time lock** - The product locks if the PIN-code has not been entered in 30 days. Enter the PIN-code to get access to the product.

3.12.4.1 To set the security level

Select 1 of 3 security levels for your product.

1. Do steps 1–3 in *To get access to the menu in the display of the product on page 21*.
2. Use the **arrow buttons** and the **OK** button to move through the menu structure *Settings > Security > Security level*.
3. Use the **arrow buttons** and the **OK** button to select the level of security.
4. Push the **OK** button.

3.12.4.2 To create a New loop signal

The loop signal is randomly selected to create a unique link between the product and the charging station. In rare cases, there may be a need to generate a new signal, for instance if two adjacent installations have a very similar signal.

1. Place the product in the charging station.
2. Do steps 1–3 in *To get access to the menu in the display of the product on page 21*.
3. Use the **arrow** buttons and the **OK** button to move through the menu structure *Security > Advanced > New loop signal*.
4. Await confirmation that the loop signal has been generated. This normally takes about 10 seconds.

3.12.4.3 To change the PIN-code

1. Do steps 1–3 in *To get access to the menu in the display of the product on page 21*.
2. Use the **arrow** buttons and the **OK** button to move through the menu structure *Settings > Security > Advanced > Change PIN-code*.
3. Enter the new PIN code.
4. Push the **OK** button.
5. Enter the new PIN code again.
6. Push the **OK** button.
7. Make a note of the new PIN code. Refer to *Introduction on page 3*.

3.12.4.4 To change the duration of the alarm

1. Do steps 1–3 in *To get access to the menu in the display of the product on page 21*.

2. Use the **arrow buttons** and the **OK** button to move through the menu structure *Security > Advanced > Duration > Duration of alarm*.
3. Use the **arrow buttons** to select a time interval of 1 to 20 minutes.
4. Push the **BACK** button.

3.12.4.5 To change the duration of the time lock

1. Do steps 1–3 in *To get access to the menu in the display of the product on page 21*.
2. Use the **arrow buttons** and the **OK** button to move through the menu structure *Security > Advanced > Duration > Duration of time lock*.
3. Use the **number buttons** to select a time interval of 1–90 days.
4. Push the **BACK** button.

3.12.5 Messages



In this menu the previous fault and information messages can be found. For some of the messages, there are tips and advice to help to rectify the fault. Refer to *Troubleshooting on page 36*.

If the product is disrupted in any way, for example it is trapped or the battery is low, a message is saved relating to the disruption and the time it happened.

If the same message is repeated several times, this may indicate that an adjustment to the installation or the product is required. Refer to *Installation on page 13*.

3.12.5.1 To read the messages

1. Do steps 1–3 in *To get access to the menu in the display of the product on page 21*.
2. Use the **arrow** buttons and the **OK** button to move through the menu structure *Messages > Fault messages* and *Messages > Info messages*.
3. Read the messages and read the *Troubleshooting* to get information and recommendations to correct the faults.

3.12.6 Weather Timer



Weather Timer automatically adjust the cutting time to the growth of the grass. The product is not permitted to operate more than the schedule settings.

Note: When using *Weather Timer*, it is recommended to make as much operating time as possible available for *Weather Timer*. Do not restrict the schedule more than necessary.

The first operation of the day is set by the schedule settings. The product always complete 1 mowing cycle, and then *Weather Timer* selects if the product will continue to operate or not.

Note: *Weather Timer* is reset if the product does not operate for more than 50 hours, or if a *Reset of all user settings* is done. *Weather Timer* is not changed if a *Reset of schedule settings* is done.

3.12.6.1 To set the Weather Timer

1. Do steps 1–3 in *To get access to the menu in the display of the product on page 21*.
2. Use the **arrow** buttons and the **OK** button to move through the menu structure *Weather Timer > Use Weather Timer*.
3. Push the **OK** button to select the *Weather Timer*.
4. Push the **BACK** button.

3.12.6.2 To set the Weather Timer frequency

Set how frequently the product cuts the grass when the *Weather Timer* is in use. There are 3 frequency levels: *Low*, *Mid* and *High*. The higher the frequency, the more sensitive the product is to the grass growth. That is, if the grass growth is high then the product is allowed to work longer.

Note: If the mowing results are not optimal when using *Weather Timer*, the schedule settings may need adjusting. Do not restrict the schedule more than necessary. Also, check that the blade disc is clean and that the blades are in good condition.

1. Do steps 1–3 in *To get access to the menu in the display of the product on page 21*.
2. Use the **arrow** buttons and the **OK** button to move through the menu structure *Weather Timer > Cutting time*.
3. Use the **arrow** buttons to select *Low*, *Mid* or *High* frequency.
4. Push the **BACK** button.

3.12.7 Installation



In the Installation menu it is possible to adapt the settings of the product for best mowing result.

3.12.7.1 Lawn Coverage and Systematic Passage Mowing

If the work area includes remote parts that are connected with narrow passages, the *Lawn Coverage* and *Systematic Passage Mowing* function are useful to be able to maintain a well-cut lawn in all parts of the yard. The *Lawn Coverage* function is used to guide the product to remote parts of the work area. The *Systematic Passage Mowing* function is used for narrow passage mowing. A guide wire must be installed to use these functions. You can set a maximum of 3 remote areas.

With the *Lawn Coverage* function the product first follows and then leaves the guide wire after a certain distance and starts to mow the lawn.

The *Systematic Passage Mowing* function is suitable to mow narrow passages of 60 cm - 1.5 m / 23 in. - 4.9 ft. width. The product moves in a pattern to cover the passage width. The product starts the *Systematic Passage Mowing* at the set distance from the charging station. When the product reaches the end of the narrow passage, the product continues and cuts the lawn as normal.

Area A, approximately 50%

Area B, approximately 30%

Area C, approximately 20%

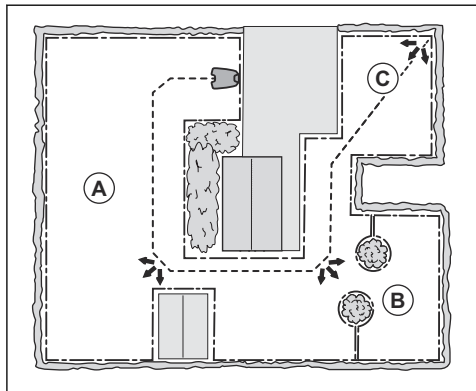

To set the Lawn Coverage function

1. Do steps 1–3 in *To get access to the menu in the display of the product on page 21*.
 2. Use the **arrow** buttons and the **OK** button to move through the menu structure *Settings > Lawn Coverage > Area 1-3*.
 3. Use the **arrow** button to select the area.
 4. Push the **OK** button.
 5. Measure the distance from the charging station to the start of the area. Measure along the guide wire. Refer to *To measure the distance from the charging station on page 25*.
-

6. Push the **arrow** buttons to select the distance, measured in m.
7. Push the **OK** button.
8. Use the **arrow** buttons to select the percentage of the cutting time the product must cut the area. The percentage is equal to the percentage of the area in relation to the complete work area.
 - a) Measure the area.
 - b) Divide the measured area with the total work area.
 - c) Convert the result to percentage.

Note: The sum of Area 1-3 must be 100% or less. If the sum is less than 100%, the product sometimes straddles the guide wire and starts to mow at the charging station.

9. Push the **BACK** button.

To set the System Passage Mowing function

Note: To prevent that the grass in the narrow passage is worn, Husqvarna recommends to set a low percentage for the *Systematic Passage Mowing*.

1. Do steps 1–3 in *To get access to the menu in the display of the product on page 21*.
2. Use the **arrow** buttons and the **OK** button to move through the menu structure *Settings > Lawn Coverage > Area 1-3*.
3. Use the **arrow** buttons to select the area.
4. Push the **OK** button.
5. Measure the distance from the charging station to the beginning of the narrow passage. Measure along the guide wire. Refer to *To measure the distance from the charging station on page 25*.

Note: Make sure that the distance to the *Systematic Passage Mowing* is set inside the narrow passage.

6. Push the **arrow** buttons to select the distance.
7. Push the **OK** button.
8. Use the **arrow** buttons to select the % of the cutting time that the product must start the narrow passage cutting.
9. Use the **arrow** buttons and the **OK** button to select *More > Systematic Passage Mowing*.
10. Push the **OK** button to enable *Systematic Passage Mowing*.
11. Push the **BACK** button.

To do a test of the Lawn Coverage function

1. Put the product in the charging station.
2. Do step 1-3 in *To get access to the menu in the display of the product on page 21*.

3. Use the **arrow** buttons and the **OK** button to move through the menu structure *Settings > Lawn Coverage > Area > More > Test*.
4. Push the **OK** button.
5. Push the **START** button.
6. Close the hatch.
7. Make sure the product can find the area.

To measure the distance from the charging station

1. Put the product in the charging station.
2. Do steps 1–3 in *To get access to the menu in the display of the product on page 21*.
3. Use the **arrow** buttons and the **OK** button to move through the menu structure *Settings > Lawn Coverage > Area > How far?*
4. Use the **arrow** buttons to set 500 m / 500 yd as a distance.
5. Push the **OK** button.
6. Use the **arrow** buttons and the **OK** button to move through the menu structure *Settings > Lawn Coverage > Area > More > Test*.
7. Push the **OK** button.
8. Push the **STOP** button when the product is at the distance you select to measure. The distance shows in the display.

To disable or enable the Lawn Coverage function

Disable or enable the *Lawn Coverage* function for each area.

1. Do steps 1–3 in *To get access to the menu in the display of the product on page 21*.
2. Use the **arrow** buttons and the **OK** button to move through the menu structure *Settings > Lawn Coverage > Area > Disable*.
3. Push the **OK** button.
4. Push the **BACK** button.

To reset the Lawn Coverage settings

You can reset the *Lawn Coverage* settings for each area and use the factory setting.

1. Do steps 1–3 in *To get access to the menu in the display of the product on page 21*.
2. Use the **arrow** buttons and the **OK** button to move through the menu structure *Settings > Lawn Coverage > Area > More > Reset*.
3. Push the **OK** button.

3.12.7.2 Methods for the product to find the charging station

The product has 3 search methods to find the charging station:

- Irregular - The product operates in the work area until it finds the signal of the charging station.

- Guide wire - The product operates in the work area until it finds the signal of the charging station or the guide wire. If it finds the guide wire the product moves along the guide wire to the charging station.
- Boundary wire - The product moves in the work area until it finds the signal of the charging station, the guide wire or the boundary wire. If it finds the boundary wire, the product moves along the boundary wire to the charging station.

The factory setting is set to mix the 3 search methods. When the battery is low the product starts to search for the charging station with the irregular method for 3 min. After 3 min the product changes search method to the guide wire method. After 11 min the product changes search method to the boundary wire method.

You can change the settings for how the product finds the charging station to adapt to the work area.

To set how the product finds the charging station

You can make manual settings to make the product search for the guide wire or the boundary wire in 0–30 min from when the battery is low.

1. Do steps 1–3 in *To get access to the menu in the display of the product on page 21*.
2. Use the **arrow buttons** and the **OK** button to move through the menu structure *Installation > To find the charging station > Overview of search methods > Guide*.
3. Push the **arrow buttons** to select 1 of the guide wires.
4. Push the **number buttons** to set the time.
5. Push the **OK** button.
6. Push the **BACK** button.
7. Use the **arrow buttons** and the **OK** button to move through the menu structure *Installation > To find the charging station > Overview of search methods > Boundary wire*.
8. Push the **number buttons** to set the time.
9. Push the **OK** button.
10. Push the **START** button and close the hatch.

To do a test of the guide wire

1. Do steps 1–3 in *To get access to the menu in the display of the product on page 21*.
2. Use the **arrow buttons** and the **OK** button to move through the menu structure *Installation > Find charging station > Guide > More > Test guide*.
3. Put the product 3 m / 9 ft. from the guide wire, facing the guide wire.
4. Push the **START** button and close the hatch.
5. Make sure the product follows the guide wire to the charging station.
6. Make sure the product docks with the charging station.

7. If the product does not dock with the charging station, change the position of the charging station or the guide wire. Refer to *To install the charging station on page 18* and *To install the guide wire on page 19*.

To do a test of the boundary wire

1. Put the product 3 m / 9 ft. from the boundary wire, facing the boundary wire.
2. Do steps 1–3 in *To get access to the menu in the display of the product on page 21*.
3. Use the **arrow buttons** and the **OK** button to move through the menu structure *Installation > Find charging station > Overview of search methods > Boundary > More > Test right / Test left*.
4. Push the **START** button and close the hatch.
5. Make sure the product follows the boundary wire to the charging station.
6. Make sure the product docks with the charging station.
7. Change the position of the charging station or the boundary wire if the product does not dock with the charging station. Refer to *To install the charging station on page 18* and *To install the guide wire on page 19*.

To change the signal range of the charging station

1. Do steps 1–3 in *To get access to the menu in the display of the product on page 21*.
2. Use the **arrow buttons** and the **OK** button to move through the menu structure *Installation > Find the charging station > Overview of search methods > Charging station range*.
3. Use the left **arrow button** to select **MAX**, **MID**, **MIN**.
4. Push the **BACK** button.

Note: It is usually better to move the charging station, than to decrease the range of the charging station signal.

3.12.7.3 Corridor width

The boundary wire corridor is the area adjacent to the boundary wire and the guide corridor is the area adjacent to the guide wire. The product uses the corridors to find the charging station. When the product moves in the direction of the charging station, it always moves to the left of the guide wire.

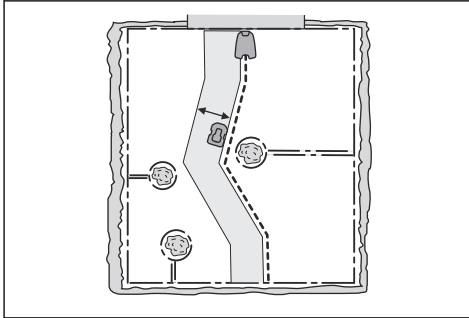

The corridor width is adjusted automatically. If it is necessary to adjust the corridor width manually for the product to operate satisfactorily, you can set the corridor width between 0-9. If guide corridor width is set to 0, the product straddles the guide wire. The factory setting is 6 for the boundary wire and 9 for the guide wire.

To set the corridor width

1. Do steps 1–3 in *To get access to the menu in the display of the product on page 21*.
2. Use the **arrow** buttons and the **OK** button to move through the menu structure *Installation > Advanced > Corridor width*.
3. Use the **arrow** buttons to select a corridor.
4. Use the **number** buttons to select a corridor width of 0-9.

Note: Make the corridor width as wide as possible for a minimum risk of lines in the lawn.

3.12.7.4 Exit angle

If the sum of the *Lawn Coverage* function is less than 100%, the product sometimes starts to mow at the charging station. The product moves away from the charging station with an exit angle between 90°–270°. The exit angles can be set to 1–2 exit sectors.

To set the exit angle

1. Do steps 1–3 in *To get access to the menu in the display of the product on page 21*.
2. Use the **arrow** buttons and the **OK** button to move through the menu structure *Installation > Advanced > Exit angles > Sector 1*.
3. Use the **number** buttons to set the angles in degrees.
4. Push the down **arrow** button.
5. Use the **number** buttons to select how frequently the product must use each sector. Set in percentage.
6. Push the **BACK** button.

3.12.7.5 Reversing distance

The reversing distance makes the product move in reverse for a set distance, before the product starts to cut the lawn. The factory setting is 60 cm / 2 ft.

To set the reversing distance

1. Do steps 1-3 in *To get access to the menu in the display of the product on page 21*.
2. Use the **arrow** button and the **OK** button to move through the menu structure *Installation > Advanced > Reversing distance*.
3. Use the **number** buttons to set the distance.
4. Push the **BACK** button.

3.12.7.6 Drive Past Wire function

The front of the product always moves past the boundary wire by a specified distance. Then the product moves rearward and changes direction. The factory setting is 32 cm / 13 in. You can select a distance of 25-40 cm / 10-15 in.

Note: If you change the distance for *Drive Past Wire*, the distance will change along the boundary wire in all parts of the work area.

To set the Drive Past Wire function

1. Do steps 1–3 in *To get access to the menu in the display of the product on page 21*.
2. Use the **arrow** button and the **OK** button to move through the menu structure *Installation > Advanced > Drive Past Wire*.
3. Use the **number** buttons to set the distance.
4. Push the **BACK** button.

3.12.8 Settings



In settings you can change the general settings to your product.

3.12.8.1 Profiles

With the function Profiles, different sets of product settings can be saved. This can be used when one product is used for more than one work areas and charging stations. The product settings and the pairing with the charging stations are saved in the profile and can easily be used again.

To save settings to a profile

1. Do steps 1–3 in *To get access to the menu in the display of the product on page 21*.
2. Use the **arrow buttons** and the **OK** button to move through the menu structure *Settings > Profiles > Use profiles > Profile A, B, C*.

- Use the **arrow buttons** and the **OK** button to select and save the profile.
- Push the **BACK** button.

If settings have been changed but not saved, the symbol * is shown beside the profile name.

To change the name of a profile

- Do steps 1–3 in *To get access to the menu in the display of the product on page 21*.
- Use the **arrow buttons** and the **OK** button to move through the menu structure *Settings > Profiles > Use profiles > Profile A, B, C. > Rename*.
- Use the **arrow buttons** and the **OK** button to select letters.
- Push the **BACK** button to save the new profile name.

To use a profile

- Do steps 1–3 in *To get access to the menu in the display of the product on page 21*.
- Use the **arrow buttons** and the **OK** button to move through the menu structure *Settings > Profiles > Use profiles > Profile A, B, C > Select*.
- Push the **BACK** button.

To connect a new charging station to a profile

- Save the settings in a profile to be used with the original charging station. Do steps 1–4 in *To save settings to a profile on page 27*.
- Put the product in the new charging station.
- Use the **arrow buttons** and the **OK** button to move through the menu structure *Security > Advanced > New loop signal*.
- Save a profile for the new charging station, or select a profile in the list. Do steps 1–4 in *To save settings to a profile on page 27*, or do steps 1–3 in *To use a profile on page 28*.

3.12.8.2 ECO mode

If *ECO mode* is activated, it switches off the signal in the boundary loop, the guide wire and the charging station, when the product is parked or is charging.

Note: Use *ECO mode* to save energy and avoid interference with other equipment, for example hearing loops or garage doors.

Note: To start the product manually in the work area, push the **STOP** button before you remove the product from the charging station. If not, the product cannot be started in the work area.

To set the ECO mode

- Do steps 1–3 in *To get access to the menu in the display of the product on page 21*.

- Use the **arrow** buttons and the **OK** button to move through the menu structure *Settings > ECO mode*.
- Push the **OK** button to select the *ECO mode*.
- Push the **BACK** button.

3.12.8.3 Spiral Cutting

The product cuts the grass in a spiral pattern if the grass is longer in an area. *Spiral cutting* can be set in 5 levels:

- Low-
- Low
- Mid
- High
- High+

The level sets how sensitive the product is to changes in grass height.

Note: *Spiral cutting* is only started in the Main area mode. Cutting in the *Secondary area* mode does not let the product to start *Spiral cutting*. *Spiral Cutting* does not start in slopes steeper than 15%.

To set the Spiral Cutting

- Do steps 1–3 in *To get access to the menu in the display of the product on page 21*.
- Use the **arrow buttons** and the **OK** button to move through the menu structure *Settings > Spiral Cutting > Use Spiral Cutting*.
- Push the **BACK** button.

To set the level of Spiral Cutting

- Do steps 1–3 in *To get access to the menu in the display of the product on page 21*.
- Use the **arrow buttons** and the **OK** button to move through the menu structure *Settings > Spiral Cutting > Use Spiral Cutting > Intensity*.
- Use the left **arrow button** to select the level of the Spiral Cutting.
- Push the **BACK** button.

3.12.8.4 General

In *General* you can change the general settings of the product.

To set the time & date

- Do steps 1–3 in *To get access to the menu in the display of the product on page 21*.
- Use the **arrow** buttons and the **OK** button to move through the menu structure *Settings > General > Time & Date*.
- Use the **number** buttons to set the time and then push the **BACK** button.
- Use the **number** buttons to set the date and then push the **BACK** button.

5. Use the **arrow** buttons to set the time format and then push the **BACK** button.
6. Use the **arrow** buttons to set the date format and then push the **BACK** button.

To set the language

1. Do steps 1–3 in *To get access to the menu in the display of the product on page 21*.
2. Use the **arrow** buttons and the **OK** button to move through the menu structure *Settings > General > Language*.
3. Use the **arrow** buttons to select language and then push the **BACK** button.

To set the country

1. Do steps 1–3 in *To do the basic settings on page 20*.
2. Use the **arrow** buttons and the **OK** button to move through the menu structure *Settings > General > Country*.
3. Use the **arrow** buttons to select country and then push the **BACK** button.

To set the unit format

1. Do steps 1–3 in *To get access to the menu in the display of the product on page 21*.
2. Use the **arrow** buttons and the **OK** button to move through the menu structure *Settings > General > Unit format*.
3. Use the **arrow** buttons to select unit format and then push the **BACK** button.

To reset all user settings

1. Do steps 1–3 in *To get access to the menu in the display of the product on page 21*.
2. Use the **arrow** buttons and the **OK** button to move through the menu structure *Settings > General > Reset all user settings*.
3. Use the right **arrow** button to select *Proceed with reset of all user settings?*
4. Push the **OK** button to reset all the user settings.

Note: *Security level, PIN code, Loop signal, Messages, Date & Time, Language and Country settings* are not reset.

The About menu

The *About* menu displays information about the product, for example serial number and firmware versions.

3.12.8.5 Frost Guard

The grass is extra sensitive to wear if the yard is covered with frost. If the *Frost Guard* is activated, the product is not allowed to start to cut the grass if the temperature is below 5° C / 41° F.

Note: The frost sensor is located inside the chassis and there can be a delay compared to the ambient temperature.

To set the Frost Guard

1. Do steps 1–3 in *To get access to the menu in the display of the product on page 21*.
2. Use the **arrow** buttons and the **OK** button to move through the menu structure *Settings > Installation > Frost Guard*.
3. Push the **OK** button to select *Frost Guard*.
4. Push the **BACK** button.

3.12.9 Accessories



Settings for accessories mounted on the product can be made in this menu.

3.12.9.1 Information

This menu handles accessories mounted on the product. Contact your local Husqvarna representative for more information on available accessories.

3.12.9.2 Automower® Connect

The product can connect to mobile devices that have the Automower® Connect app installed. The Automower® Connect app has Long-range cellular connectivity and Short-range Bluetooth® connectivity. Refer to *Automower® Connect app on page 21*.

Note: Automower® Connect is always connected to your product while the mobile device have connection with the mobile network and the product is switched on.

Note: All countries do not support Automower® Connect because of regional specified cellular systems. The included Automower® Connect life-time service only applies if there is a third part sub-supplier of 2G/3G/4G available in the operational area. In some countries Bluetooth® is not available because of legal reasons.

3.12.9.3 To avoid collisions with the Automower® house

The wear on the product and the Automower® house decreases when you select *Avoid collisions with mower*.

1. Do steps 1–3 in *To get access to the menu in the display of the product on page 21*.
2. Use the arrow buttons and the **OK** button to move through the menu structure *Accessories > Mower house > Avoid collisions with mower*.

Note: If *Avoid collisions with mower* is selected it can result in grass that is not cut around the charging station.

3.12.9.4 Terrain kit

When using the terrain wheels with weights, special settings are needed to compensate for more weight.

To set the Terrain kit

1. Do steps 1–3 in *To get access to the menu in the display of the product on page 21*.
2. Use the **arrow buttons** and the **OK** button to move through the menu structure *Accessories > Terrain kit > Enable Terrain kit*.
3. Push the **OK** button to enable or disable the function.
4. Push the **BACK** button.

3.12.9.5 FlexiFence

If you install the FlexiFence accessory, you must enable the Zone generator function of the product.

3.12.9.6 To enable the Zone generator function

1. Do steps 1–3 in *To get access to the menu in the display of the product on page 21*.
2. Use the **arrow** buttons and the **OK** button to move through the menu structure *Settings > Installation > Zone generator*.
3. Push the **OK** button to enable *Zone generator*.
4. Push the **BACK** button.

4 Operation

4.1 To use the ON/OFF button



WARNING: Read and understand the safety chapter before you use the product.

- Push the **ON/OFF** button for 3 seconds to set the product to ON. Make sure that the LED indicator comes on.
- The product is ON and in power save mode if the LED indicator flashes. Push the **ON/OFF** button for 3 seconds to set the product to ON.

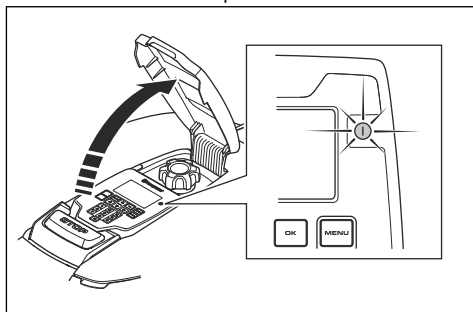

- Push the **ON/OFF** button for 3 seconds to set the product to OFF. Make sure that the LED indicator goes out.

4.2 To start the product

1. Push the **STOP** button to open the hatch.
2. Push the **ON/OFF** button for 3 seconds. The display is lit up.
3. Enter the PIN code.
4. Push the **START** button.
5. Select an operating mode. Refer to *Operating modes - Start on page 31*.
6. Push the **OK** button.
7. Close the hatch.

Note: If the product is parked in the charging station, the product will start to operate when the battery is fully charged and if the *Schedule* settings is set for operation

Note: The first weeks after installation the perceived sound level when cutting the grass may be higher than expected. When the product has cut the grass for some time, the perceived sound level is much lower.

4.2.1 Operating modes - Start

- *Main area*
- *Secondary area*
- *Override schedule*
- *Spot cutting*

4.2.1.1 Main area

Use the operating mode *Main area* for the product to cut and charge automatically.

4.2.1.2 Secondary area

Use *Secondary area* operating mode to cut secondary areas. You must move the product manually between the main area and the secondary area. The product cuts for a selected period of time or until the battery is empty.

Note: You must put the product manually in the charging station to charge the product when it is in a secondary area. The product will move out from the charging station and stop when the battery is charged. You must select an operating mode to start the product.

Note: If you will cut the main area after the battery is charged, set the product to *Main area* mode before you put the product in the charging station.

4.2.1.3 Override schedule

Use the operating mode *Override schedule* to temporarily override the *Schedule* settings for *24h* or *3 days*.

Note: It is not possible to cut more than the maximum cutting time for each day. Refer to *Make an estimate of the necessary operating time on page 22*.

4.2.1.4 Spot cutting

Use the operating mode *Spot cutting* to cut a selected area in a spiral pattern. You must move the product manually to the selected area before you start the *Spot cutting* operating mode.

Note: After the product has operated in the operating mode *Spot cutting*, it will automatically start to cut in the operating mode *Main area* or *Secondary area*.

4.3 To park the product

1. Push the **STOP** button to open the hatch.
2. Push the **ON/OFF** button for 3 seconds. The display is lit up.
3. Enter the PIN code.

4. Push the **PARK** button.
5. Select an operating mode. Refer to *Operating modes - Park* on page 32.
6. Push the **OK** button.
7. Close the hatch.

4.3.1 Operating modes - Park

- *Park until further notice*
- *Start with schedule*

4.3.1.1 Park until further notice

Use the operating mode *Park until further notice* for the product to go back to the charging station. The product will stay in the charging station until you select a new operating mode.

4.3.1.2 Start again with next schedule

Use the operating mode *Start again with next schedule* for the product to go back to the charging station. The product will stay in the charging station until the next *Schedule* setting.

4.4 To stop the product

1. Push the **STOP** button to make the product and the cutting motor stop.

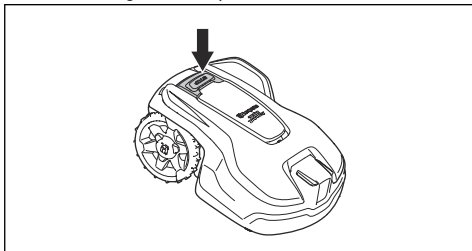

4.5 To set the product to OFF

1. Push the **STOP** button to open the hatch.
2. Push the **ON/OFF** button for 3 seconds.
3. Make sure that the LED indicator on the keypad is off to make sure that the product is set to OFF.



WARNING: Only charge the product using a charging station which is intended for it. Incorrect use may result in electric shock, overheating or leakage of corrosive liquid from the battery.

In the event of leakage of electrolyte flush with water and seek medical help if it comes in contact with the eyes etc.

When the product is new or has been stored for a long period, the battery can be empty and must be charged before you can start the product. In the *Main area* mode, the product cuts and charges automatically.

1. Push the **ON/OFF** for 3 seconds button to start the product.
2. Put the product in as far as possible in the charging station.
3. Make sure that the charging plates on the charging station connects to the contact plates on the product.
4. Do a check that the display shows the message *CHARGING* to make sure that the product is connected correctly to the charging station.

4.7 Adjust the cutting height



CAUTION: During the first weeks after a new installation, the cutting height must be set to **MAX** to avoid damaging the loop wire. After this, the cutting height can be lowered step by step every week until the desired cutting height has been reached.

The cutting height can be varied from **MIN** (2 cm / 0.8 in.) to **MAX** (5 cm / 2 in.).

4.7.1 To adjust the cutting height

1. Push the **STOP** button to stop the product.
2. Open the hatch.

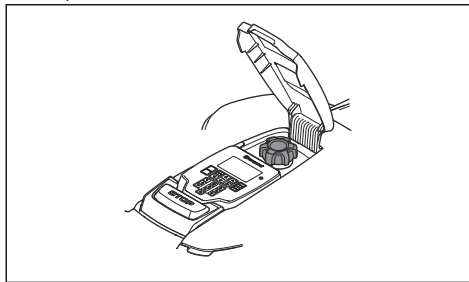

3. Turn the cutting height adjustment knob to select a cutting height.
 - a) Turn clockwise to increase the cutting height.
 - b) Turn counterclockwise to decrease the cutting height.

5 Maintenance

5.1 Introduction - maintenance



WARNING: The product must be switched off before any maintenance is done.



WARNING: Wear protective gloves.

For better operation and longer service life, make sure to clean the product regularly and replace worn parts. All maintenance and servicing must be done according to Husqvarna's instructions. Refer to *Warranty on page 50*.

When the product is first used, the blade disc and blades should be inspected once a week. If the amount of wear during this period has been low, the inspection interval can be increased.

It is important that the blade disc rotates easily. The edges of the blades should not be damaged. The lifetime of the blades varies immensely and depends for instance on:

- Operating time and size of the work area.
- Type of grass and seasonal growth.
- Soil, sand and use of fertilizers.
- The presence of objects such as cones, windfalls, toys, tools, stones, roots and the like.

The normal life is 3 to 6 weeks when used under favorable conditions. Refer to *Replacement of the blades on page 34* on how to replace the blades.

Note: Working with blunt blades gives a poorer mowing result. The grass is not cut cleanly and more energy is needed resulting in the product not mowing such a large area.

5.2 Clean the product



CAUTION: Never use a high-pressure washer to clean the product. Never use solvents for cleaning.

The product does not operate satisfactorily in slopes if the wheels are blocked with grass. Use a soft brush to clean the product. The product can be cleaned with running water from a water hose.

Husqvarna recommends to use a special cleaning and maintenance kit, available as accessory. Speak to your Husqvarna representative for more information.

5.2.1 To clean the chassis and blade disc

Examine the blade disc and blades weekly. To clean the product fully, the body of the product can be removed. If the product is dirty, use a brush or a water hose to clean the product. Do not use a high-pressure washer to clean the product.

1. Push the **ON/OFF** button to switch off the product. The product is disabled when the indicator lamp is not lit.
2. Carefully pull the top cover at the rear, the front and the middle.

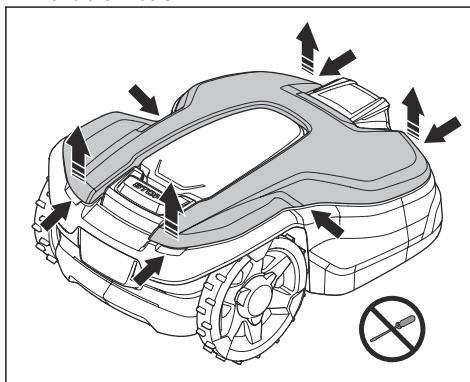

3. Lift up the top cover to remove it.
4. Find the 4 positions where the body is attached.

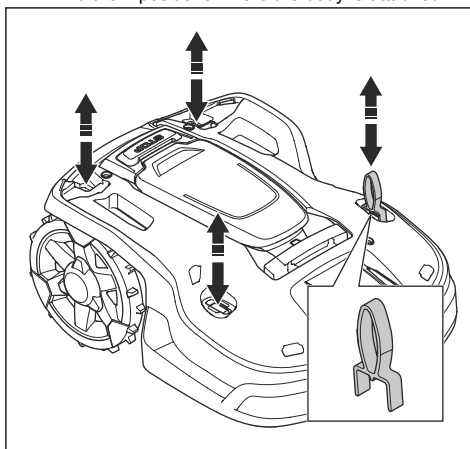

5. Push the maintenance tool down in 1 of the 4 positions, and pull the body up.
6. Continue with the remaining positions while you hold the body up.

- Carefully lift the body at the rear and fold it over to remove the body, do not remove the charging cable.

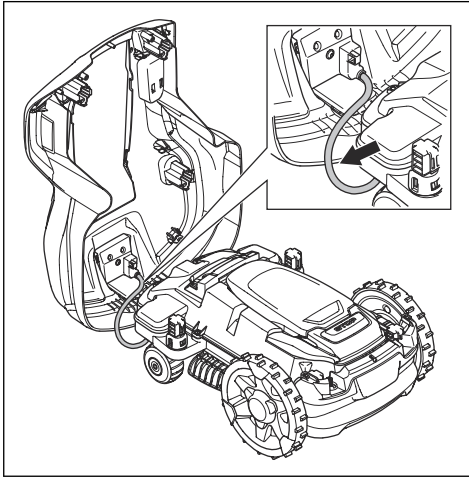

Note: Make sure that the grommets for the charging cable are correctly installed to seal against moisture after you remove the body of the product.

- Clean the blade disc and chassis with a brush. At the same time, make sure that the blade disc rotates freely. Make sure that the blades are not damaged and can pivot freely.

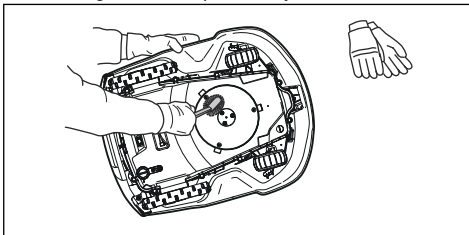

- To install the body of the product, put it on the chassis and push into position.
- To install the top cover, put it on the body of the product and push into position.

Note: Make sure that the grommets for the charging cable are correctly installed to seal against moisture.

5.2.2 To clean the wheels

The product does not operate satisfactorily in slopes if the wheels are blocked with grass.

- Use a soft brush to clean the wheels.

5.2.3 To clean the body of the product

- Use a moist cloth and a weak soap solution to clean the body of the product.

5.2.4 To clean the charging station



WARNING: Disconnect the power supply from the power outlet before maintenance, or when you clean the charging station or power supply.



CAUTION: Do not use a high-pressure washer or running water to clean the charging station.

Note: The product cannot enter the charging station if there are objects in the charging station. Clean the charging station regularly.

- Remove grass, twigs and other objects from the charging station.

5.3 Replacement of the blades



WARNING: Husqvarna can only guarantee safety if you use Husqvarna original blades with the embossed crowned H-mark logotype.

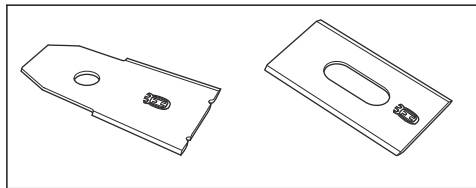

WARNING: You must replace the screws when you replace the blades. The used screws can wear quickly and make the blade come loose, this can cause serious injury.

Replace worn or damaged blades for a safe operation. Replace the blades regularly for a satisfactory cut result and a low energy use. All 3 blades and screws must be replaced at the same time to get a balanced cutting system.

5.3.1 To replace the blades

- Push the **STOP** button
- Push the **ON/OFF** button for 3 seconds to switch off the product.

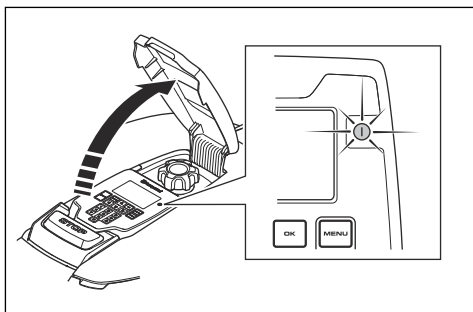

- Checking and, if required, replacing wear items such as blades and bearings.
- Testing the product's battery capacity as well as a recommendation to replace battery if necessary.
- If new firmware is available, the product is updated.

3. Make sure that the indicator lamp on the keypad is out.
4. Turn the product upside down. Put the product on a soft and clean surface to avoid scratching the body and the hatch.
5. Rotate the skid plate so that its holes align with the screws for the blade.
6. Remove the 3 screws with a screwdriver.
7. Remove the 3 blades.
8. Attach 3 new blades and screws.
9. Make sure that the blades can pivot freely.

5.4 Battery



CAUTION: Charge the battery fully before you put the product into storage. If the battery is not fully charged it can cause damage to the battery.

If the operating time of the product is shorter than usual between charges, this means that the battery is at the end of its life cycle. Replace the battery to extend the operating time.

Note: The battery life is related to the length of the season and how many hours a day the product operates. A long season or many hours of operation a day means that the battery must be replaced more regularly.

5.5 Winter service

Take your product to your Husqvarna central service for service prior to winter storage. Regular winter service will maintain the product in good condition and create the best conditions for a new season without any disruptions.

Service usually includes the following:

- Thorough cleaning of the body, the chassis, the blade disc and all other moving parts.
- Testing of the product's function and components.

6 Troubleshooting

6.1 Introduction - troubleshooting

In this chapter you can find information and help about faults and symptoms of the product. You can find more information and FAQ (Frequently Asked Questions) on www.husqvarna.com.

6.2 Fault messages

The fault messages in the table below are shown in the display of the product. Speak to your Husqvarna representative if the same message shows frequently.

Message	Cause	Action
<i>No loop signal</i>	The power supply or low-voltage cable is not connected.	If the LED status indicator on the charging station is not lit, it shows that there is no power. Examine the power outlet connection and the residual-current device. Make sure that the low-voltage cable is connected to the charging station.
	The power supply or low-voltage cable is damaged or not connected.	Replace the power supply or low-voltage cable.
	The boundary wire is not connected to the charging station.	Check that the boundary wire connectors are fitted properly to the charging station. Replace connectors if damaged. Refer to <i>To install the boundary wire on page 18</i> .
	The boundary wire is broken.	Do a check of the LED status indicator on the charging station. If it shows break in the boundary wire, replace the damaged section with a new loop wire and splice using an original coupler.
	<i>ECO mode</i> is activated and the product has attempted to start outside the charging station.	Put the product in the charging station, start the product and close the hatch.
	The boundary wire is crossed on its way to and from an island.	Check that the boundary wire is laid according to instructions, e.g. in the right direction around the island. Refer to <i>To install the boundary wire on page 18</i> .
	The pairing between the product and the charging station is lost.	Put the product in the charging station and generate a new loop signal. Refer to <i>To create a New loop signal on page 23</i> .
	Disturbances from metal objects (fences, reinforcement steel) or buried cables close by.	Try to move the boundary wire and/or make islands in the work area to increase the signal strength.
	The product is too far from the boundary wire.	Redo the installation of the boundary wire so that all parts of the work area is maximum 35 m / 115 ft. from the boundary wire.
<i>Connection NOT changed</i>	Failed to change loop signal.	Try to create a <i>New loop signal</i> several times. Refer to <i>To create a New loop signal on page 23</i> . If the problem stays speak to your authorized service technician.

Message	Cause	Action
<i>Wheel motor blocked, left/right</i>	Grass or other object is wrapped around the drive wheel.	Clean the wheels and around the wheels.
<i>Wheel motor overloaded, left/right</i>		
<i>Wheel drive problem, right/left</i>		
<i>Cutting system blocked</i>	Grass or other object is wrapped around the drive wheel.	Clean the wheels and around the wheels.
	The blade disc lies in a pool of water.	Move the product and prevent the collection of water in the work area.
	The grass is too high.	Cut the grass before you install the product. Make sure that the grass is maximum 10 cm / 3.9 in.
<i>Cutting system imbalance</i>	Too few or too many blades.	Do a check of the blades on the blade disc.
<i>Outside working area</i>	The boundary wire connections to the charging station are crossed.	Check that the boundary wire is connected correctly.
	The boundary wire is too close to the edge of the work area.	Check that the boundary wire has been laid according to the instructions. Refer to <i>To examine where to put the boundary wire on page 14</i> .
	The work area slopes too much by the boundary loop.	
	The boundary wire is laid in the wrong direction around an island.	
	Disturbances from metal objects (fences, reinforcement steel) or buried cables close by.	Try moving the boundary wire.
	The product finds it hard to distinguish the signal from another product installation close by.	Put the product in the charging station and generate a new loop signal.
<i>Empty battery</i>	The product cannot find the charging station.	Change the position of the guide wire. Refer to <i>To install the guide wire on page 19</i> .
	The battery is spent.	Replace the battery. Refer to <i>Battery on page 35</i> .
	The charging station's antenna is defective.	Check if the indicator lamp in the charging station flashes red. Refer to <i>Indicator lamp in the charging station on page 41</i> .
	The charging plates on the product or contact plates on the charging station are corroded.	Clean the charging and contact plates using a fine grade emery cloth. If the problem stays speak to your authorized service technician.
<i>Battery problem</i>	Temporary battery or firmware related issue in the product.	Restart the product. If the problem stays speak to your authorized service technician.
	Incorrect type of battery.	Use original batteries recommended by the manufacturer.
<i>Battery temperature outside limits</i>	The temperature in the battery is too high or too low to start operation.	No action. The product will start to operate when the temperature is in limits.

Message	Cause	Action
<i>Wrong PIN code</i>	Wrong PIN code has been entered. Five attempts are permitted, and the keypad is then blocked for a period of time.	Enter the correct PIN code. If the PIN code is incorrect, use the link in the app to send the PIN code to your registered e-mail address. If you have not registered the e-mail address, contact your local Husqvarna representative.
<i>No drive Slipped</i>	The product has got caught in something and has been slipping.	Free the product and rectify the reason for the lack of drive. If it is due to wet grass, wait until the lawn has dried before using the product.
	The work area includes a steep slope.	Steep slopes should be isolated. Refer to <i>To put the boundary wire in a slope on page 15</i> .
	The guide wire is not laid diagonally in the slope.	Make sure that the guide wire is installed diagonally across the slope. Refer to <i>To make a secondary area on page 16</i> .
<i>Collision sensor problem, front/rear</i>	The drive wheels on the product are blocked.	Free the product and correct the cause of problem. If the problem stays, speak to your authorized service technician.
<i>Alarm! Mower switched off</i>	The alarm is activated because the product had been switched off.	Adjust the security level in the <i>Security</i> menu. Refer to <i>To set the security level on page 23</i> .
<i>Alarm! Mower stopped</i>	The alarm is activated because the product has been stopped.	
<i>Alarm! Mower lifted</i>	The alarm is activated because the product has been lifted.	
<i>Alarm! Mower tilted</i>	The alarm is activated because the product has been tilted.	
<i>Alarm! Mower was moved</i>	The alarm is activated because the product has been lifted.	
<i>Charging station blocked</i>	The contact between the charging plates on the product on the and contact plates on the charging station may be poor and the product has made a number of attempts to charge.	Put the product in the charging station and check that the charging plates and contact plates make good contact.
	An object is in the way of the product that prevents it to enter the charging station.	Remove the object.
	The charging station is tilted or bent.	Put the baseplate on level ground.
	The guide wire is not installed correctly.	Check if the guide wire is installed according to the instructions. Refer to <i>To install the guide wire on page 19</i> .
<i>Stuck in charging station</i>	There is an object in the way of the product preventing it from leaving the charging station.	Remove the object.
<i>Charging system problem</i>	Incorrect type of battery.	Use original batteries recommended by the manufacturer.
<i>Charging current too high</i>	Wrong or faulty power supply unit.	Restart the product. If the problem stays speak to your authorized service technician.

Message	Cause	Action
<i>Trapped</i>	The product is stuck in a small area behind a number of obstacles.	Check if there are any obstacles which make it hard for the product to move on from this location. Remove the obstacles or create an island around the obstacles. Refer to <i>To make an island on page 16</i> .
<i>Mower tilted</i>	The product is tilted more than the maximum angle.	Move the product to a flat area.
<i>Upside down</i>	The product is leaning too much or has turned over.	Turn the product the right way up.
<i>Needs manual charging</i>	The product is set to the <i>Secondary area</i> operating mode.	Put the product in the charging station.
<i>Next start hh:mm</i>	The schedule setting prevents the product from operating.	Change the schedule settings. Refer to <i>Schedule on page 22</i> .
	The product has reached its maximum cutting time for the day.	This behavior is normal and no action is required.
	The clock or date in the product is not correct.	Set the time. Refer to <i>To set the time & date on page 28</i> .
<i>Today's mowing completed</i>	The product has reached its maximum cutting time for the day.	This behavior is normal and no action is required. Refer to <i>Make an estimate of the necessary operating time on page 22</i> .
<i>Lifted</i>	The lift sensor has been activated as the product has been lifted.	Check that the product body can move freely around its chassis. Remove or create an island around objects that can cause the chassis to be lifted. If the problem stays speak to your authorized service technician.
<i>Electronic problem</i>	Temporary electronic or firmware related issue in the product.	Restart the product. If the problem stays speak to your authorized service technician.
<i>Loop sensor problem, front/rear</i>		
<i>Tilt sensor problem</i>		
<i>Temporary problem</i>		
<i>Invalid sub-device combination</i>		
<i>Temporary battery problem</i>		
<i>Safety function faulty</i>		
<i>Connectivity problem</i>	Potential problem on the connectivity circuit board in the product.	Restart the product. If the problem stays speak to your authorized service technician.
<i>Connectivity settings restored</i>	The connectivity settings was restored due to a fault.	Check and change the settings if needed.
<i>Poor signal quality</i>	The connectivity circuit board in the product is assembled upside down, or the product itself is tilted or upside down.	Make sure that the product is not upside down or tilted. If the problem stays speak to your authorized service technician.
<i>Slope too steep</i>	The product stopped because the slope is too steep.	Change the installation of the boundary wire to exclude this steep part of the work area.

Message	Cause	Action
<i>Zone generator problem</i> <i>FlexiFence problem</i>	The battery of the FlexiFence accessory is low. The FlexiFence accessory does not operate when the battery is empty. The product can cut in the stay-out zone if you start the product before you charge the FlexiFence accessory.	Park the product and charge the FlexiFence accessory before you start the product.
	The temperature in the FlexiFence accessory is a higher than the maximum limit and is set to off.	Put the product in an area with protection from the sun. Let the temperature of the FlexiFence accessory decrease before you start the product.
<i>Difficult finding home</i>	The product has followed the boundary wire several laps but has not found the charging station.	Examine the settings of the corridor width for the boundary wire.

6.3 Information messages

The information messages in the table below are shown in the display of the product. Speak to your Husqvarna representative if the same message shows frequently.

Message	Cause	Action
<i>Low battery</i>	The product cannot find the charging station.	Change the position of the guide wire. Refer to <i>To install the guide wire on page 19</i> .
	The battery is at the end of its life cycle.	Replace the battery. Refer to <i>Battery on page 35</i> .
	The antenna of the charging station is defective.	Do a check if the indicator lamp in the charging station flashes red. Refer to <i>Indicator lamp in the charging station on page 41</i> .
	The charging plates on the product or contact plates on the charging station are defective because of corrosion.	Clean the charging plates and contact plates. If the problem stays speak to your Husqvarna service.
<i>Settings restored</i>	A <i>Reset all user settings</i> has been done.	Usual operation of the product.
<i>Guide 1 not found</i>	The guide wire is not connected to the charging station.	Connect the guide wire to the charging station. Refer to <i>To install the guide wire on page 19</i> .
	Damage in the guide wire.	Replace the damaged section with new guide wire.
	The guide wire is not connected to the boundary loop.	Connect the guide wire correctly to the boundary loop. Refer to <i>To install the boundary wire on page 18</i> .
<i>Guide calibration failed</i>	The product has not calibrated the guide wire because of an error.	Install the guide wire correctly. Refer to <i>To install the guide wire on page 19</i> .
<i>Guide calibration done</i>	The product has calibrated the guide wire.	Usual operation of the product.
<i>Connection changed</i>	New loop signal changed.	Usual operation of the product.

6.4 Indicator lamp in the charging station

The indicator lamp in the charging station must show a solid or flashing green light for a correct installation. If not, follow the instructions in the troubleshooting guide below.

Speak to your Husqvarna customer service for more information.

Light	Cause	Action
Green solid light	Good signals	Usual operation of the product.
Green flashing light	The signals are good and <i>ECO mode</i> is enabled.	Usual operation of the product. Refer to <i>ECO mode on page 28</i> .
Blue flashing light	The boundary wire is not connected to the charging station.	Make sure that the boundary wire is correctly installed in the charging station. Refer to <i>To install the boundary wire on page 18</i> .
	Damage in the boundary wire.	Find out where the damage is. Replace the damaged section with new boundary wire.
Red flashing light	Interference in the antenna of the charging station.	Speak to your Husqvarna customer service.
Red solid light	Error in the circuit board or incorrect power supply in the charging station. The error must be corrected by an authorized service technician.	Speak to your Husqvarna customer service.

6.5 Symptoms

If your product does not work as expected, follow the symptoms guide below.

There is a FAQ (Frequently Asked Questions) on www.husqvarna.com which provides more detailed answers to a number of standard questions. Contact Husqvarna customer service if you still cannot find the reason for the fault.

Symptoms	Cause	Action
The product has difficulty docking.	The guide wire is not laid in a long straight line that is far enough out from the charging station.	Check that the charging station has been installed according to the instructions in <i>To examine where to put the guide wire on page 17</i>
	The guide wire is not inserted in the slot under the charging station.	Make sure that the guide wire is in the correct position below the charging station. Refer to <i>To install the guide wire on page 19</i> .
	The charging station is not on a level surface.	Place the charging station on a surface that is entirely level. Refer to <i>To examine where to put the charging station on page 13</i> .
The product runs at the wrong time	The clock or the date in the product is not correct.	Set the clock or date. Refer to <i>To set the time & date on page 28</i> .
	The start and stop times for mowing are incorrect.	Change the <i>Schedule</i> settings. Refer to <i>To set the schedule on page 22</i> .
The product vibrates.	Damaged blades lead to imbalance in the cutting system.	Inspect the blades and screws and replace them if necessary. Refer to <i>Replacement of the blades on page 34</i> .
	Too many blades in the same position lead to imbalance in the cutting system.	Check that only one blade is fitted at each screw.
	Different versions (thickness) of blades are used.	Check if the blades are of different versions.
The product runs, but the blade disc does not rotate.	The product searches for the charging station, or is reversing out of the charging station.	No action. The blade disc does not rotate when the product is searching for the charging station.
The product mows for shorter periods than usual between charges.	Grass or other foreign object blocks the blade disc.	Remove and clean the blade disc. Refer to <i>To clean the chassis and blade disc on page 33</i> .
	The battery is spent.	Replace the battery. Refer to <i>Battery on page 35</i> .
	Dull blades. More energy is needed when cutting the grass.	Replace the blades. Refer to <i>Replacement of the blades on page 34</i> .
Both the mowing and charging times are shorter than usual.	The battery is spent.	Replace the battery. Refer to <i>Battery on page 35</i> .

Symptoms	Cause	Action
The product is parked for hours in the charging station.	The product has reached its maximum cutting time for the day. Refer to <i>Make an estimate of the necessary operating time on page 22</i> .	No action.
	The hatch is closed but the START button is not pushed.	Push the STOP button to open the hatch. Enter the PIN code and confirm with the OK button. Push the START button and then close the hatch.
	Parking mode is activated.	Change the operating mode. Refer to <i>Operating modes - Park on page 32</i> .
	The product is not allowed to operate if the battery temperature is too high or too low.	Check that the charging station is placed in an area with protection from the sun.
Uneven mowing results.	The product works too few hours per day.	Increase the mowing time. Refer to <i>Schedule on page 22</i> .
	The shape of the work area requires the use of <i>Lawn coverage</i> function for the product to find its way to all remote areas.	Steer the product to a remote area. Refer to <i>Lawn Coverage and Systematic Passage Mowing on page 24</i> .
	The <i>How often?</i> setting is incorrect in relation to the layout of the work area.	Check that the correct <i>How often?</i> value is selected.
	The work area is too large.	Try limiting the work area or extending the schedule. Refer to <i>Schedule on page 22</i> .
	Dull blades.	Replace all the blades. Refer to <i>Replacement of the blades on page 34</i> .
	Long grass in relation to the set cutting height.	Increase the cutting height and then successively lower it.
	Accumulation of grass by the blade disc or around the motor shaft.	Check that the blade disc rotates freely and easily. If not, screw off the blade disc and remove grass and foreign objects. Refer to <i>To clean the chassis and blade disc on page 33</i> .
The product detects false collisions and moves rearwards and turns where there is no obstacle.	Terrain wheels are installed, but the Terrain Kit setting is not enabled. Special setting is needed to compensate behavior for additional weight.	Enable Terrain Kit setting. Refer to <i>Terrain kit on page 30</i> .

6.6 Find breaks in the loop wire

Breaks in the loop wire are usually the result of unintentional physical damage to the wire such as when gardening with a shovel. In countries with ground frost, also sharp stones that move in the ground can damage the wire. Breaks can also occur due to the wire being stretched excessively during installation.

Mowing the grass too low right after the installation can damage wire insulation. Damage to the insulation may not cause disruptions until several weeks or months later. To avoid this, always select the maximum cutting height the first weeks after installation and then lower the height one step at a time every second week until the desired cutting height has been reached.

A defective splicing of the loop wire can also lead to disruptions several weeks after the splice was done. A faulty splice can, for example, be the result of the coupler not being pressed together hard enough with a pair of pliers, or that a coupler of lower quality than the original coupler has been used. Please first check all known splices before further troubleshooting is done.

A wire break can be located by gradually halving the distance of the loop where the break may have occurred until there is only a very short section of the wire left.

The following method does not work if *ECO mode* is activated. Make sure first that *ECO mode* is switched off. Refer to *ECO mode on page 28*.

1. Check that the indicator lamp in the charging station flashes blue, which indicates a break in the boundary loop. Refer to *Indicator lamp in the charging station on page 41*.

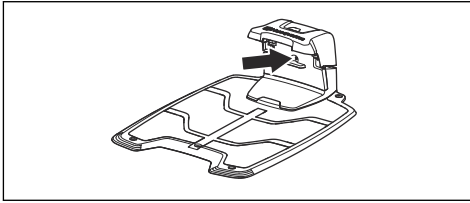

2. Check that the boundary wire connections to the charging station are properly connected and not damaged. Check that the indicator lamp in the charging station is still flashing blue.
3. Switch the connections between the guide wire and the boundary wire in the charging station. Start by switching connection AL and GUIDE.

If the indicator lamp has a solid green light, then the break is somewhere on the boundary wire between AL and the point where the guide wire is connected to the boundary wire (thick black line in the illustration).

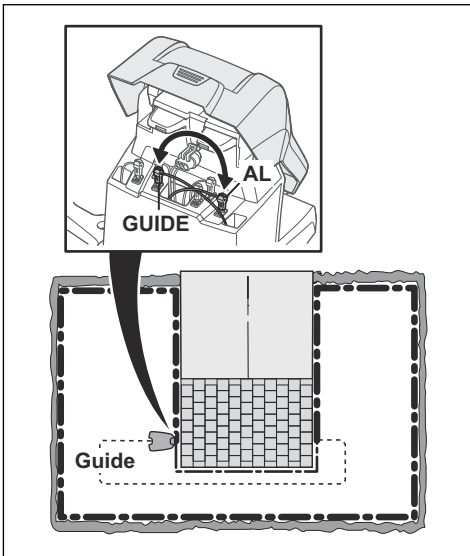

To rectify the fault you will need boundary wire, connector(s) and coupler(s):

- a) If the suspected boundary wire is short then it is easiest to exchange all of the boundary wire between AL and the point where the guide wire is connected to the boundary wire (thick black line).

- b) If the suspected boundary wire is long (thick black line) then do as follows: Put AL and GUIDE back to their original positions. Then disconnect AR. Connect a new loop wire to AR. Connect the other end of this new loop wire at the middle of the suspected wire section.

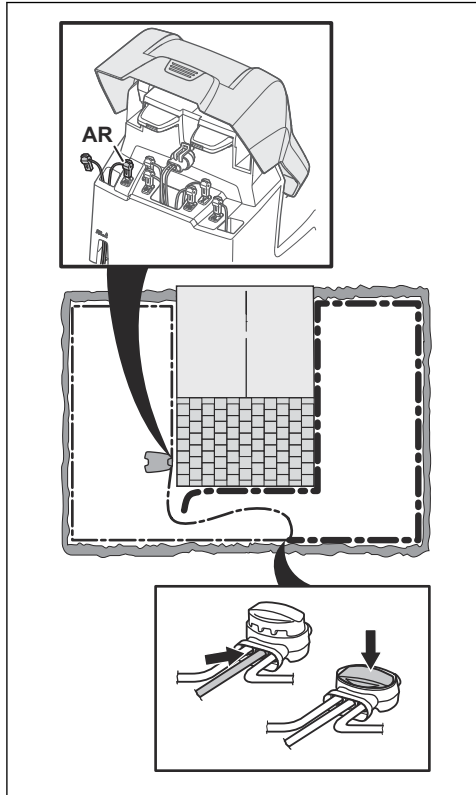

If the indicator lamp now is green, then the break is somewhere in the wire between the disconnected end to the point where the new wire is connected (thick black line below). In that case, move the connection for the new wire closer to the disconnected end (roughly at the middle of the suspected wire section) and check again if the indicator lamp is green.

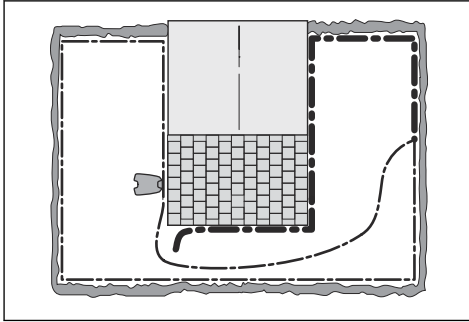

Continue until only a very short section of the wire remains which is the difference between a solid green light and a flashing blue light. Then follow instruction in step 5 below.

4. If indicator lamp still flashes blue in step 3 above: Put AL and GUIDE back in their original positions. Then switch AR and GUIDE. If indicator lamp now is lit with a solid green light then disconnect AL and connect a new boundary wire to AL. Connect the other end of this new wire at the middle of the suspected wire section. Follow the same approach as in 3a) and 3b) above.
5. When the break is found, the damaged section must be replaced with a new wire. Always use original couplers.

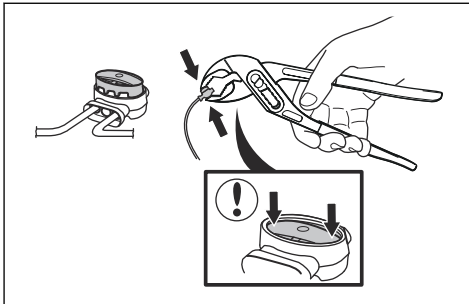

7 Transportation, storage and disposal

7.1 Transportation

The supplied Li-ion batteries obey the Dangerous Goods Legislation requirements.

- Obey all applicable national regulations.
- Obey the special requirement on package and labels for commercial transportations, including by third parties and forwarding agents.

7.2 Storage

- Fully charge the product. Refer to *To charge the battery on page 32*.
- Switch off the product. Refer to *To set the product to OFF on page 32*.
- Clean the product. Refer to *Clean the product on page 33*.
- Keep the product in a dry, frost free space.
- Keep the product with all wheels on level ground during storage, or use a wall hanger.
- If you keep the charging station indoors, disconnect and remove the power supply and all the connectors from the charging station. Put the end of each connector wire in a connector protection box.

Note: If you keep the charging station outdoors, do not disconnect the power supply and the connectors.

- Contact Husqvarna sales representative about what accessories are available for your product.

7.3 Disposal

- Obey the local recycling requirements and applicable regulations.
- For questions about how to remove the battery, refer to *To remove the battery on page 46*.

7.3.1 To remove the battery



CAUTION: Only remove the battery when you dispose the product. When you remove the warranty seal, the Husqvarna warranty is no longer applicable.

1. Remove the top cover and the body of the product. Follow steps 1-7 in *To clean the chassis and blade disc on page 33*.
2. Remove the 14 screws with a Torx 20.

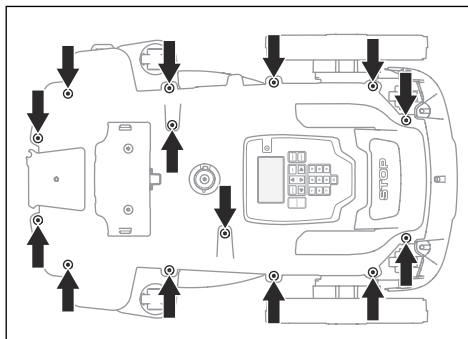

3. Lift the rear edge of the top section of the chassis.
4. Disconnect the cable from the main circuit board.
5. Remove the top section of the chassis.
6. Remove the screw that holds the battery with a Torx 20.

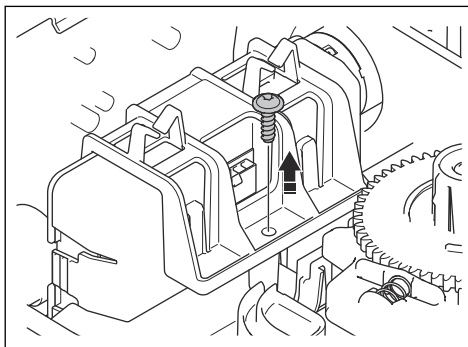

7. Push to detach the clips and lift up the battery holder.

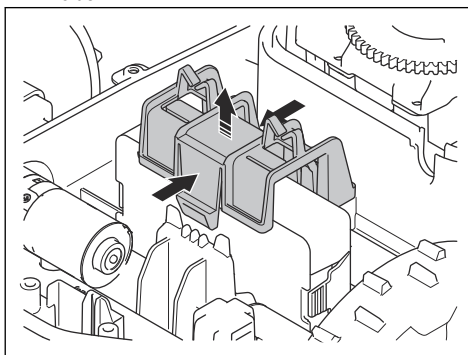

8. Disconnect the battery cable from the main circuit board.

8 Technical data

8.1 Technical data

Dimensions	Automower® 305	Automower® 310 Mark II	Automower® 315 Mark II
Length, cm/in.	57/22.4	57/22.4	57/22.4
Width, cm/in.	43/16.9	43/16.9	43/16.9
Height, cm/in.	25/9.8	25/9.8	25/9.8
Weight, kg/lb	9.4/21	9.4/21	9.4/21

Electrical system	Automower® 305	Automower® 310 Mark II	Automower® 315 Mark II
Battery, Lithium-Ion 18.5 V/2.0 Ah Art. No.	590 21 42-07, 590 21 42-08	590 21 42-07, 590 21 42-08	590 21 42-07, 590 21 42-08
Battery, Lithium-Ion 18 V/2.0 Ah Art. No.	590 21 42-02, 590 21 42-04, 590 21 42-06	590 21 42-02, 590 21 42-04, 590 21 42-06	590 21 42-02, 590 21 42-04, 590 21 42-06
Battery, Lithium-Ion 18.25 V/2.0 Ah Art. No.	590 21 42-03	590 21 42-03	590 21 42-03
Power supply (28V DC), V AC	100-240	100-240	100-240
Low-voltage cable length, m/ft	5/16.4	10/32.8	10/32.8
Mean energy consumption at maximum use	5 kWh/month for a work area of 600m ² /0.15acre	8 kWh/month for a work area of 1000m ² /0.25acre	10 kWh/month for a work area of 1500m ² /0.37acre
Charging current, A DC	1.3	1.3	1.3
Type of Power Supply Unit ⁷	ADP-40BR XX, ADP 28EW XX, FW7313/28/D/XX/Y/1.3/PI, FW7313/28/D/XX/Y/1.3	ADP-40BR XX, ADP 28EW XX, FW7313/28/D/XX/Y/1.3/PI, FW7313/28/D/XX/Y/1.3	ADP-40BR XX, ADP 28EW XX, FW7313/28/D/XX/Y/1.3/PI, FW7313/28/D/XX/Y/1.3
Average mowing time, min	60	60	60
Average charging time, min	60	60	60

Boundary wire antenna	Automower® 305	Automower® 310 Mark II	Automower® 315 Mark II
Operating Frequency Band, Hz	100-80000	100-80000	100-80000
Maximum magnetic field, dBuA/m ⁸	82	82	82
Maximum Radio-frequency power, mW@60m ⁹	<25	<25	<25

⁷ XX, YY can be any alphanumeric characters or blank for marketing purpose only, no technical differences.

⁸ Measured according to EN 303 447.

⁹ Maximum active output power to antennas in the frequency band in which the radio equipment operates.

Sound data ¹⁰	Automower® 305	Automower® 310 Mark II	Automower® 315 Mark II
Sound level, perceived, dB (A)	59	59	60
Measured sound power noise level, dB (A)	58	58	60
Noise emissions uncertainties, KWA dB (A)	1	1	2
Sound pressure noise level at the operator's ear, dB (A) ¹¹	50	50	52

Mowing	Automower® 305	Automower® 310 Mark II	Automower® 315 Mark II
Cutting system	3 pivoted cutting blades	3 pivoted cutting blades	3 pivoted cutting blades
Cutting motor speed, rpm	2200	2200	2300
Power consumption during cutting, W+/- 20%	20	20	20
Cutting height, cm/in.	2-5/0.8-2.0	2-5/0.8-2.0	2-5/0.8-2.0
Cutting width, cm/in.	22/8.7	22/8.7	22/8.7
Narrowest possible passage, cm/in.	60/24	60/24	60/24
Maximum slope for work area, %	40	40	40
Maximum slope for boundary wire, %	15	15	15
Maximum length boundary wire, m/ft	800/2600	800/2600	800/2600
Maximum length guide loop, m/ft ¹²	400/1300	400/1300	400/1300
Maximum distance to boundary wire m/ft	35/115	35/115	35/115
Area capacity, m ² / acre, +/- 20%	600/0.15	1000/0.25	1500/0.37

IP-code	Automower® 305	Automower® 310 Mark II	Automower® 315 Mark II
Robotic lawn mower	IPX5	IPX5	IPX5
Charging station	IPX1	IPX1	IPX1
Power supply	IP44/IPX4	IP44/IPX4	IP44/IPX4

Power Class	
Bluetooth® Output power	8 dBm

does not guarantee full compatibility between the product and other types of wireless systems such as remote controls, radio transmitters, hearing loops, underground electric animal fencing or similar.

¹⁰ Determined according to Directive 2006/42/EC and standard EN 50636-2-107. Except Sound level, perceived that is measured according to ISO 11094:1991.

¹¹ Sound pressure noise uncertainties K_{pA} , 2-4 dB (A)

¹² The guide loop is the loop that if formed by the guide wire and the part of the boundary wire from the junction with the guide wire to the right connection in the charging station.

8.2 Registered trademarks

The *Bluetooth*[®] word mark and logos are registered trademarks owned by *Bluetooth SIG, inc.* and any use of such marks by Husqvarna is under license.

9 Warranty

9.1 Warranty terms

Husqvarna® warranty covers this product's functionality for a period of 2 years from date of purchase. The warranty covers serious faults relating to materials or manufacturing faults. Within the warranty period, we will replace the product or repair it at no charge if the following terms are met:

- The product and the charging station may only be used in compliance with the instructions in this Operator's Manual. This manufacturer's warranty does not affect warranty entitlements against the dealer/retailer.
- End-users or non-authorized third parties must not attempt to repair the product.

Examples of faults which are not included in the warranty:

- Damage caused by water seepage from using a high-pressure washer, or from being submerged under water, for example when heavy rain forms pools of water.
- Damage caused by lightning.
- Damage caused by improper battery storage or battery handling.
- Damage caused by using a battery that is not a Husqvarna original battery.
- Damage caused by not using Husqvarna original spare parts and accessories, such as blades and installation material.
- Damage to the loop wire.
- Damage caused by non-authorized changing or tampering with the product or its power supply.

The blades and wheels are seen as disposable and are not covered by the warranty.

If an error occurs with your Husqvarna product, please contact Husqvarna customer service for further instructions. Please have the receipt and the product's serial number at hand when contacting Husqvarna customer service.



Husqvarna[®]

AUTOMOWER[®] is a trademark owned by Husqvarna AB.
Copyright[®] 2022 HUSQVARNA. All rights reserved.

www.husqvarna.com

Original instructions

1142744-26



2022-03-14