

# SOIL-CLIK™

Soil Moisture System

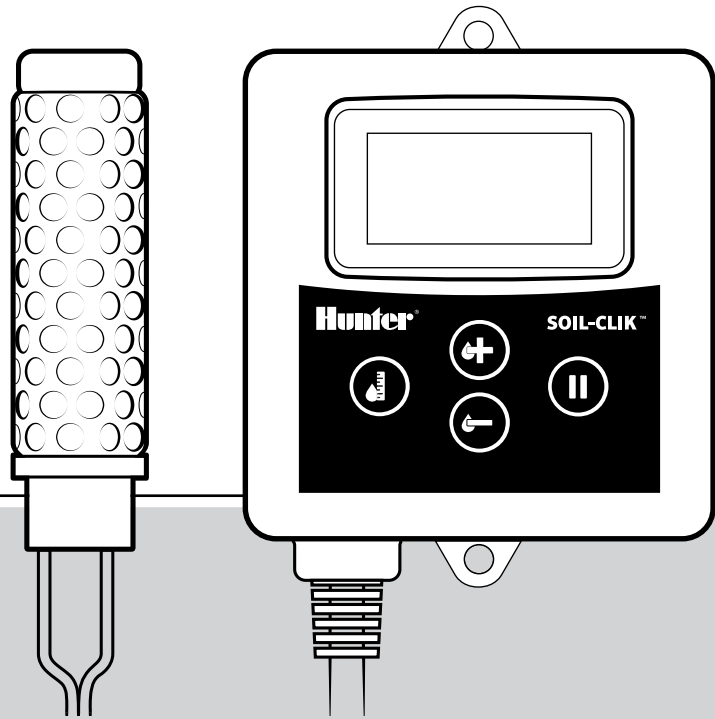

Owner's Manual and  
Installation Instructions

**Hunter®**

# Table of Contents

---

## **Introduction and Installation**

- 3 Specifications
- 4 Choosing the Probe Location
- 7 Installing the Soil-Clik Probe
- 10 Connecting the Probe to the Module
- 11 Choosing the Module Location

## **Connecting the Module to Hunter Controllers**

- 12 Overview
- 13 X-Core®
- 14 Pro-C®
- 15 I-Core®
- 16 ACC
- 17 Common Interrupt (Most AC-powered Controllers)
- 18 Using Soil-Clik with Solar Sync®

## **Programming and Operations**

- 19 LCD Screen Callouts
- 20 Operation

## **Troubleshooting Guide**

- 22 Problems, Causes and Solutions

# Specifications

---

Soil-Clik is a soil moisture system that prevents overwatering when the soil is wet. Soil-Clik is designed for use with Hunter controllers that have normally-closed smart sensor inputs, or with any AC powered control system by interrupting the common wire to the valves.

## **Module Dimensions:**

Height: 4.5" (11.4 cm)

Width: 3.5" (8.9 cm)

Depth: 1.25" (3.2 cm)

Power: 24 VAC, 100 mA max

## **Probe Dimensions:**

Height: 3.25" (8.25 cm)

Diameter: 7/8" (2.22 cm)

Wire to Probe: 1000 ft (300 m) max.,

18 AWG (1 mm<sup>2</sup>) Direct Burial Wire

For more detailed information, application notes, or assistance, please visit us at [www.hunterindustries.com](http://www.hunterindustries.com).

# Choosing the Probe Location

The moisture sensing Soil-Clik probe must be installed within 1000 ft (300 m) of the Soil-Clik module, using 18 AWG (1 mm<sup>2</sup>) Direct Burial (UF) wire.

## Choosing the Zone

Install the probe within the last typical zone to irrigate, so that normal irrigation will not interrupt watering prematurely.

 **NOTE**

**Choose a zone with full sun exposure that is in the fastest-drying area of the landscape.** If necessary, move valve wires, so that this is the last (highest-numbered) station to water.

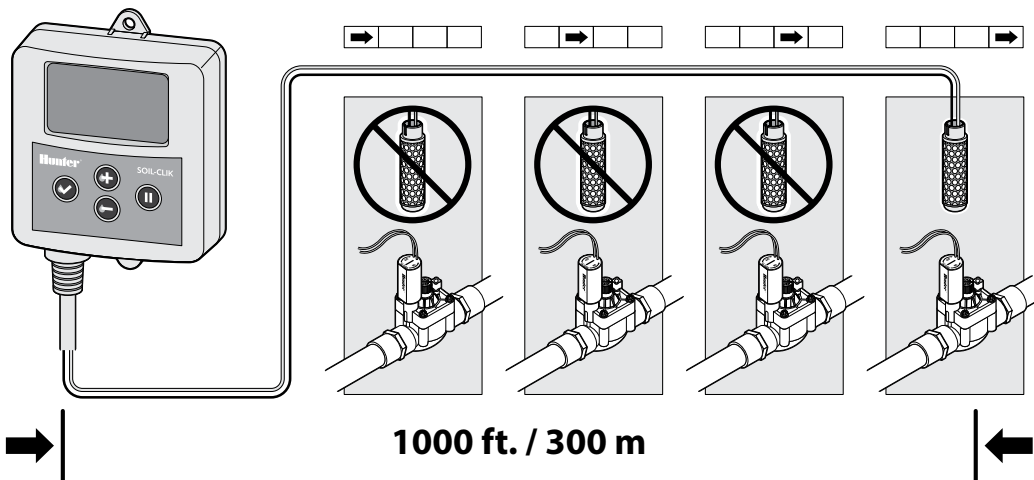

## Choosing the Probe Location *(continued)*

---

### Choosing the Exact Spot

Select an area with full sun exposure that represents the fastest-drying irrigated area.

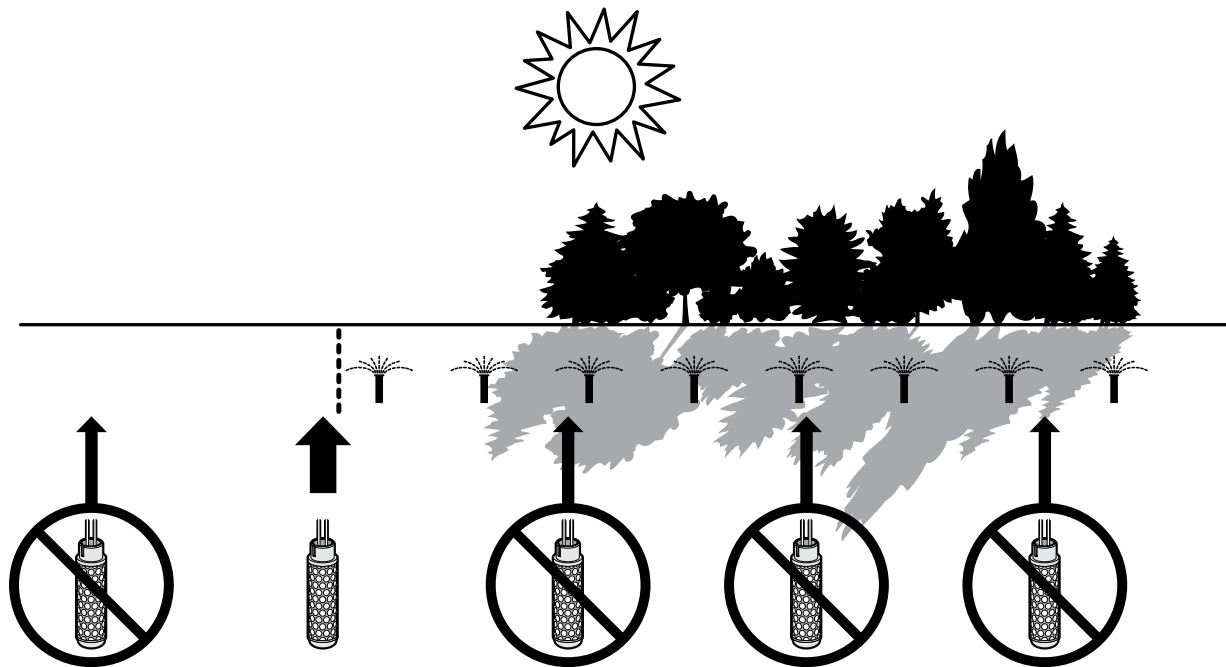

# Choosing the Probe Location *(continued)*

---

## Place in the Root Zone

In turf applications, the probe should be placed in the root zone, approximately 6" (15 cm) deep (adjust for actual turf conditions).

For shrubs or trees, select a deeper depth that matches the root zone. For new plantings, choose a spot halfway down the root ball, adjacent to native soil.

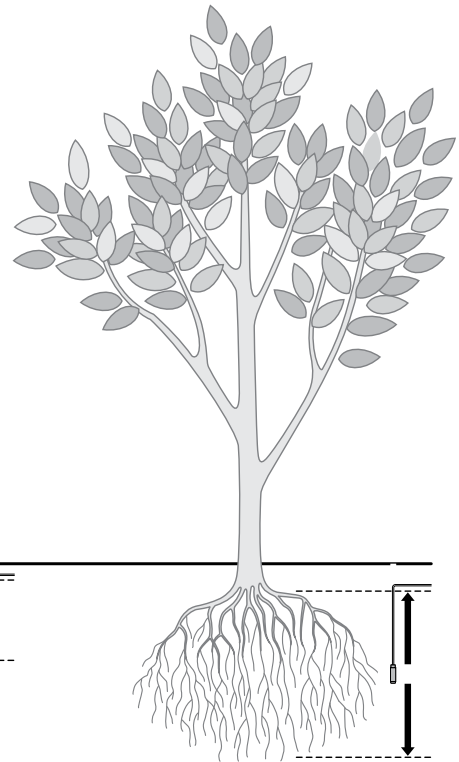

# Installing the Soil-Clik Probe

1. Soak lower two-thirds of probe for 30 minutes before installing. Do not allow water to cover the top cap where wires are connected.

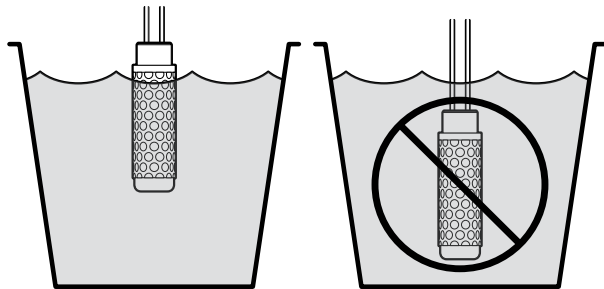

2. Use ½" (12 mm) PVC pipe to make a vertical hole to desired depth in the soil (outside diameter 7/8" (22 mm)).

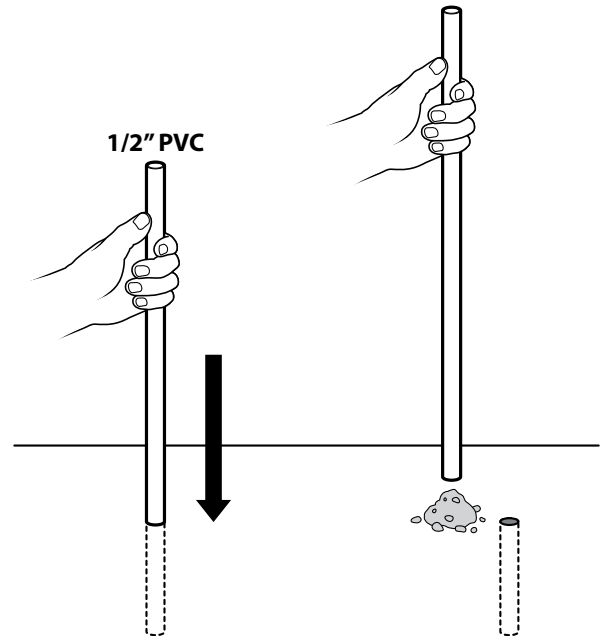

## Installing the Soil-Clik Probe *(continued)*

3. Mix a slurry of native soil and water, and pour into the hole.

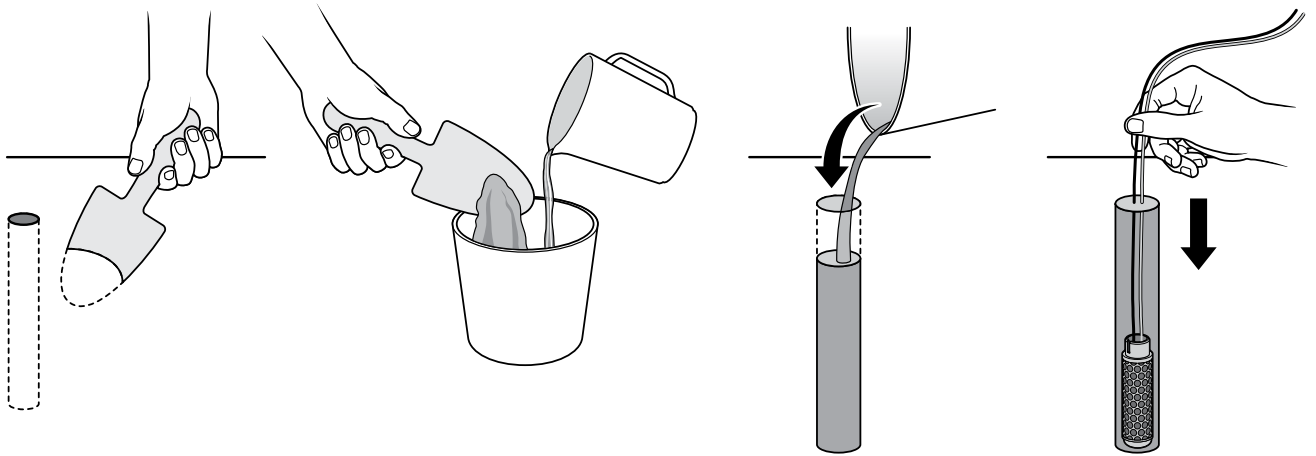

4. Place sensor in vertical position (do not tilt more than 45°) at bottom of hole.



**Do NOT install probe horizontally!**

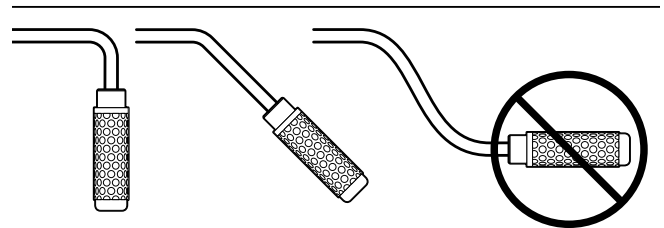



## Installing the Soil-Clik Probe *(continued)*

---

5. Pack native soil tightly around probe. Soil must be in full contact with probe.

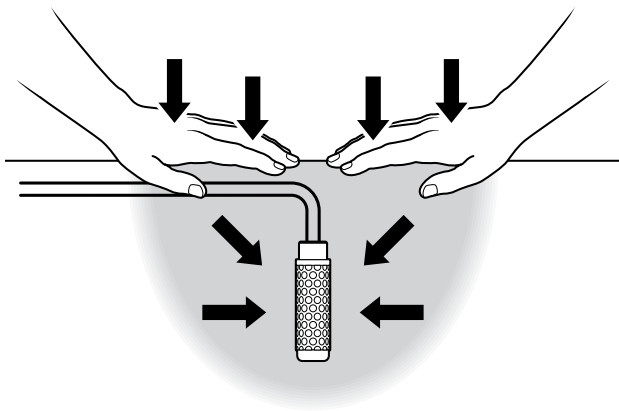

6. Allow the probe to acclimate for 2 to 3 days and water normally, before proceeding to sensor-based irrigation.

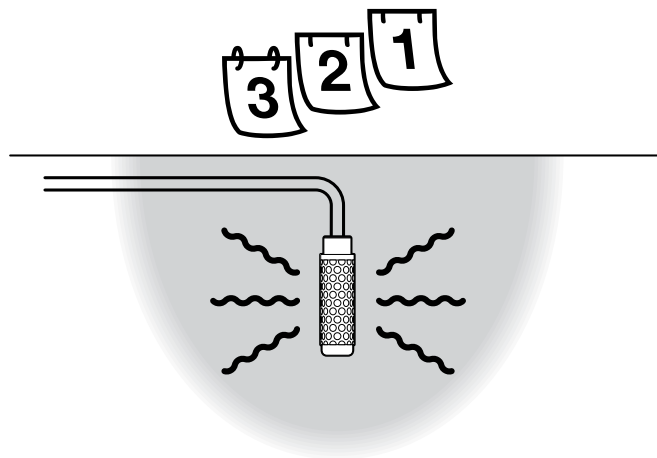

# Connecting the Probe to the Module

Use only 18 AWG (1 mm<sup>2</sup>) or larger direct burial rated wire, up to 1000 ft (300 m) from the module.

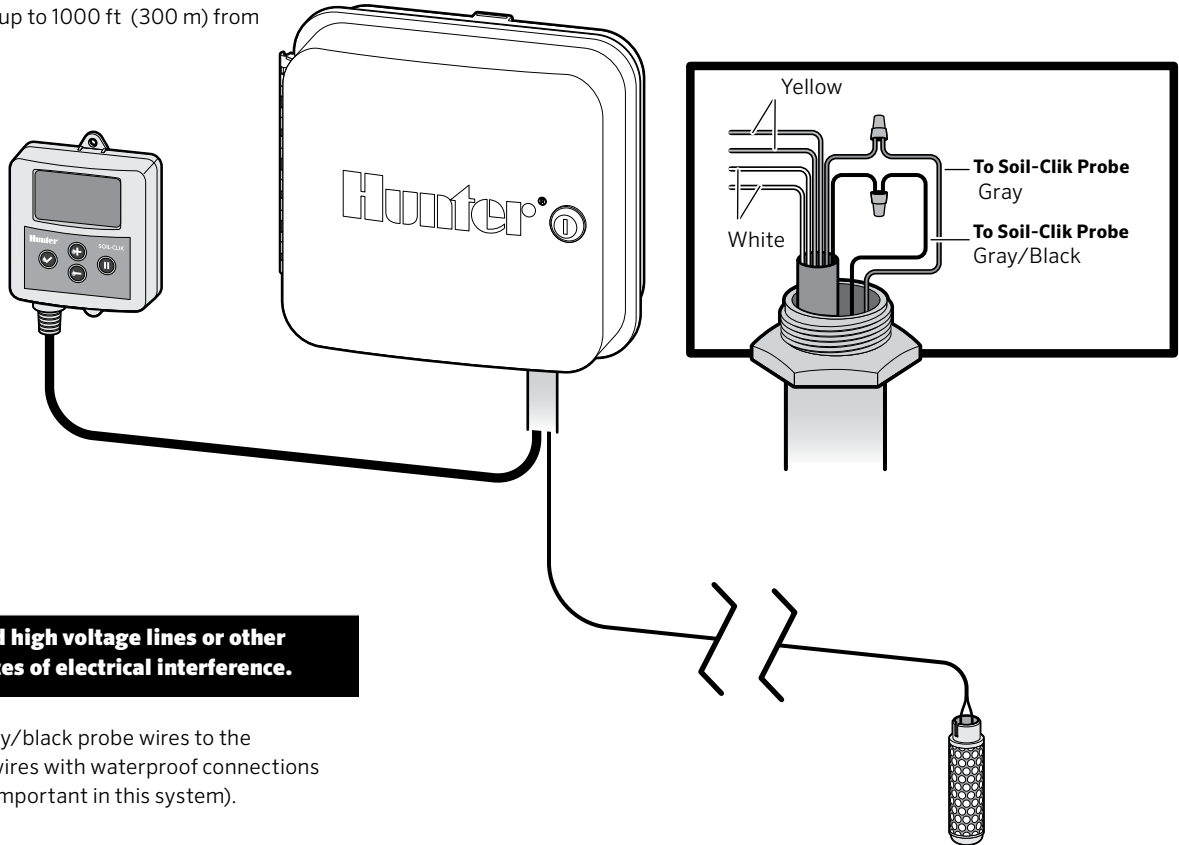

**Avoid high voltage lines or other sources of electrical interference.**

Connect the gray/black probe wires to the 2 gray module wires with waterproof connections (polarity is not important in this system).

# Choosing the Module Location

---

The Soil-Clik module is designed for outdoor installation when necessary. However, electronics will benefit from a protected location when practical.

Mount within 6 ft (2 m) of the host controller.

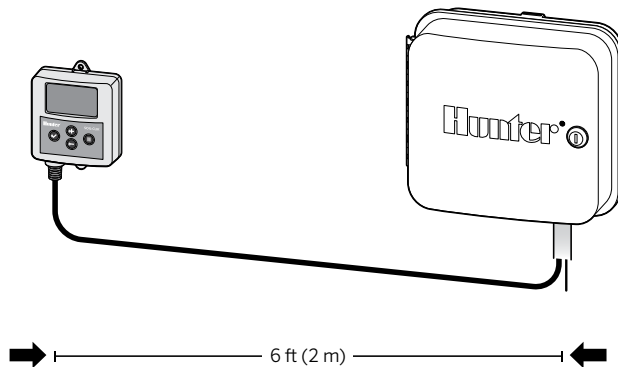

An indoor location, or inside the controller enclosure (ACC, I-Core) is recommended.

**If module must be outdoor, locate away from direct sunlight and sprinkler spray for best results.**

**Avoid placing module near electrical boxes and sources of electrical interference.**

# Connecting the Module to Hunter Controllers

---

**Gray Wires:** Connection to Soil-Clik Probe.

**Yellow Wires:** Soil-Clik Module power, requires 24 V AC power (100 mA, max).

**White Wires:** Module output, to Hunter controller sensor input, or to interrupt 24 V common wiring to field.

Route all wires through low-voltage conduit hole in controller enclosure.

Make all external connections with waterproof connectors.



**Do not connect the Soil-Clik to high voltage (120/230 VAC) wiring!**

# Connecting the Module to Hunter Controllers *(continued)*

## X-Core®

1. **Yellow** power wires to X-Core **24 VAC** terminals.
2. **White** wires to Sensor (**SEN**), or common interrupt (page 17).

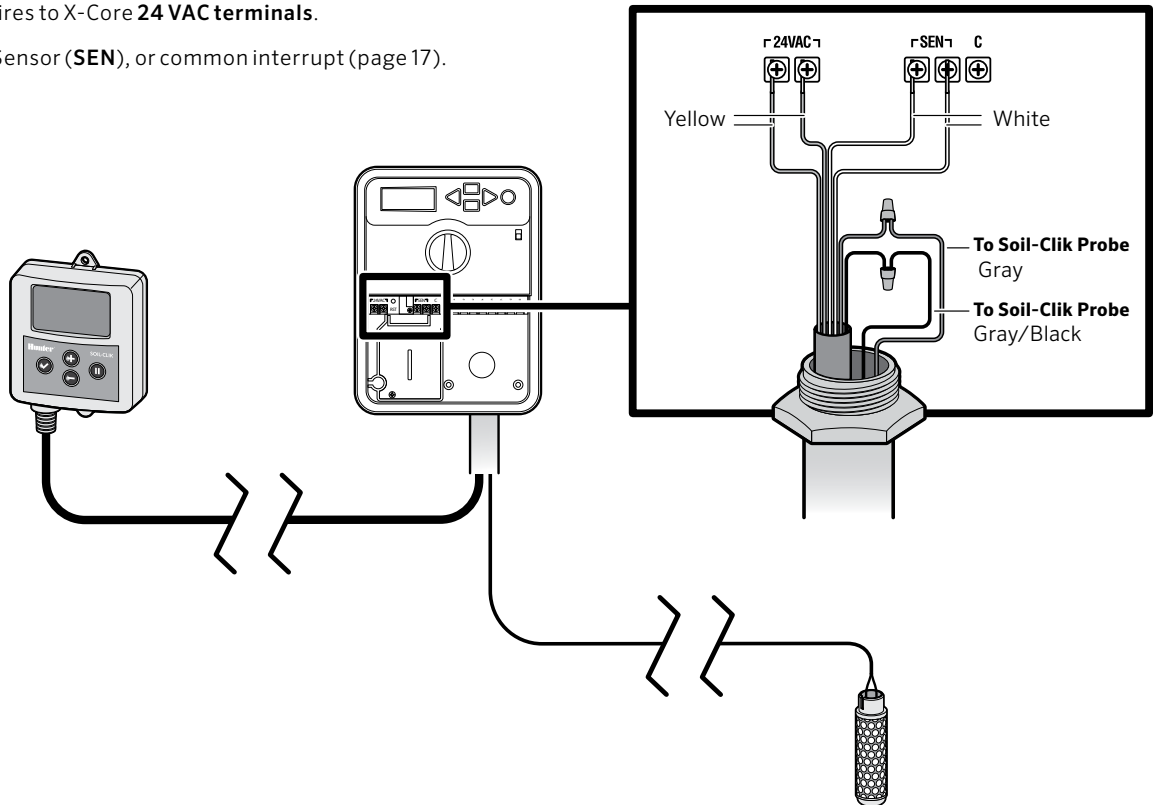

# Connecting the Module to Hunter Controllers *(continued)*

## Pro-C®

1. **Yellow** power wires to Pro-C **AC1** and **AC2**.
2. **White** wires to Sensor or common interrupt (page 17).

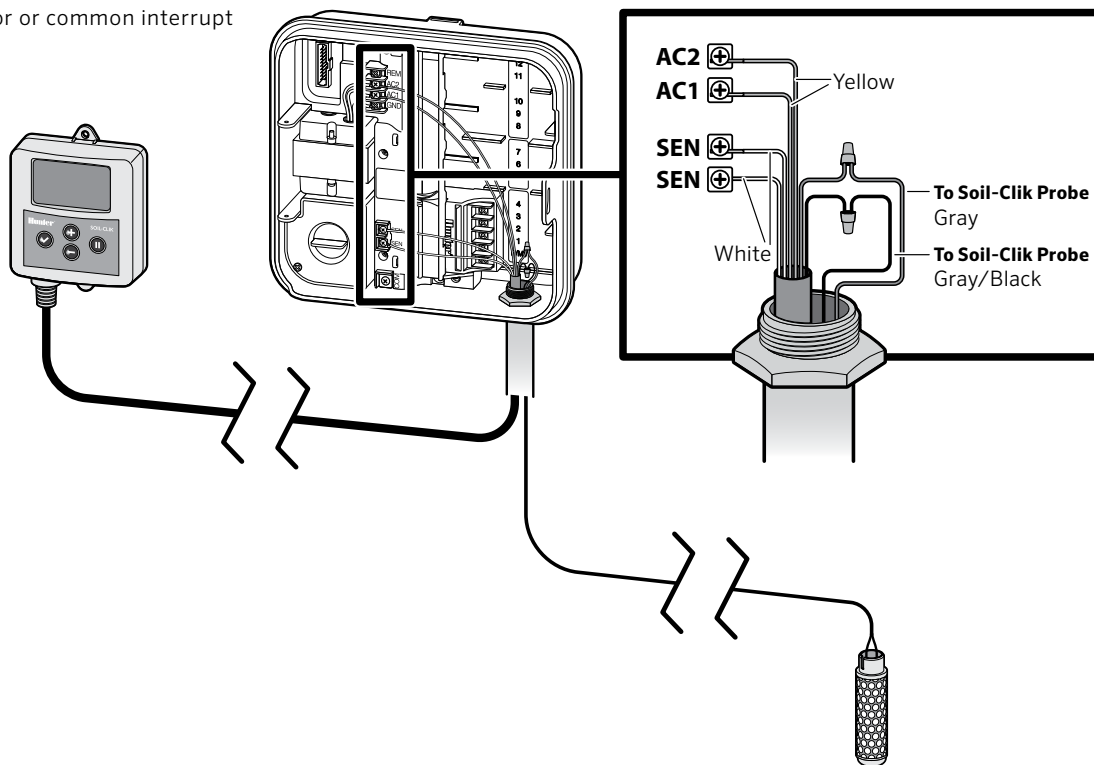

# Connecting the Module to Hunter Controllers *(continued)*

## I-Core®

1. **Yellow** power wires to I-Core **AC1** and **AC2**.
2. **White** wires to **S1**, **S2** or **S3** terminals.

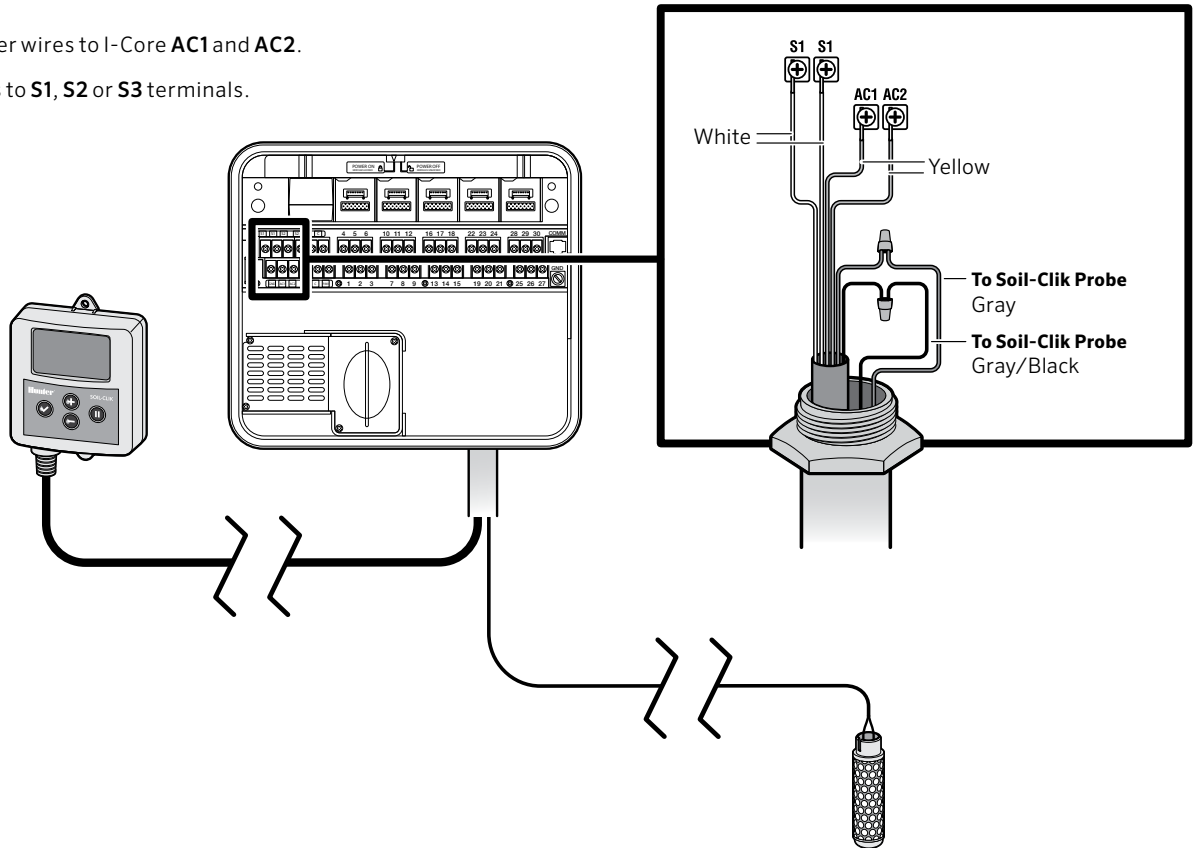

# Connecting the Module to Hunter Controllers *(continued)*

## ACC

1. **Yellow** power wires to **24 VAC** terminal and **Com** terminal.
2. **White** wires to any sensor **S1 through S4**.

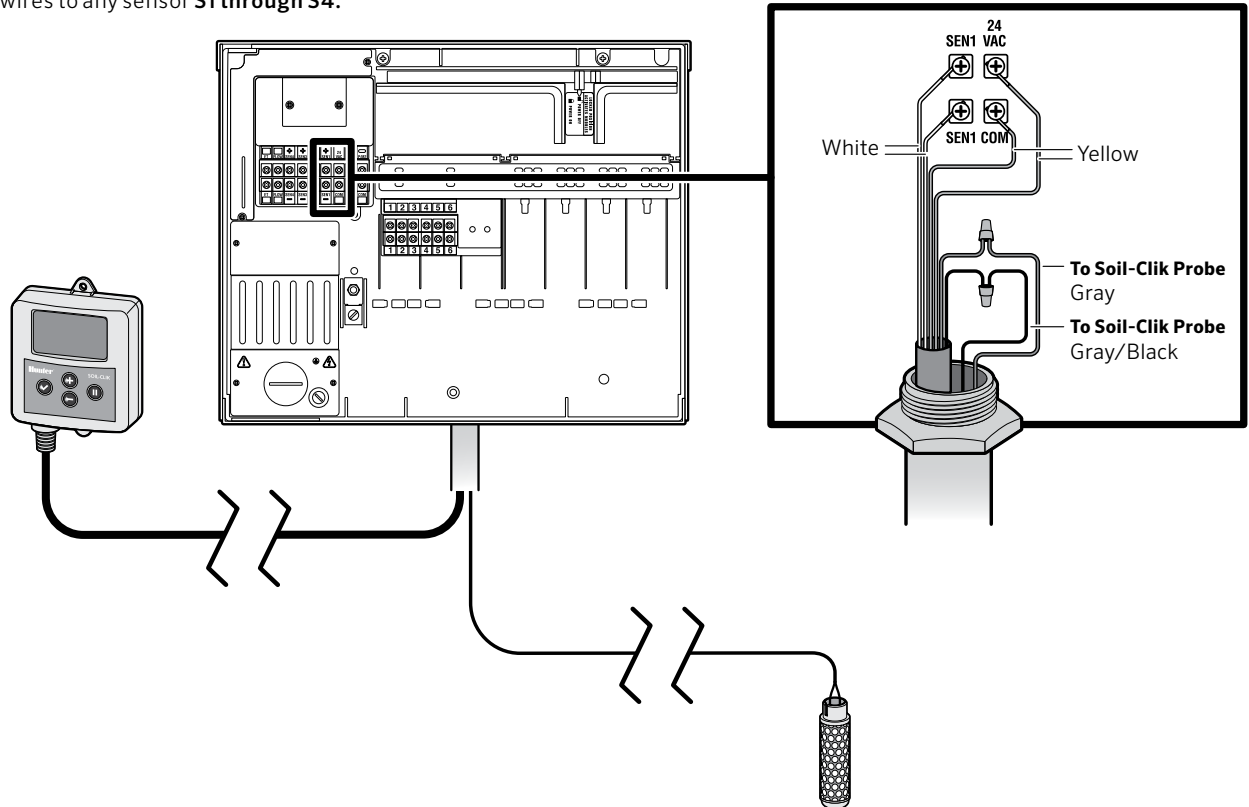



# Connecting the Module Directly to Valve Wiring (Common)

## Common Interrupt (most AC-powered controllers)

1. Connect **Yellow** power wires to **24 VAC** power in the controller.
2. Cut field common wire(s), and splice one **Soil-Clik White wire** to each end of the common.

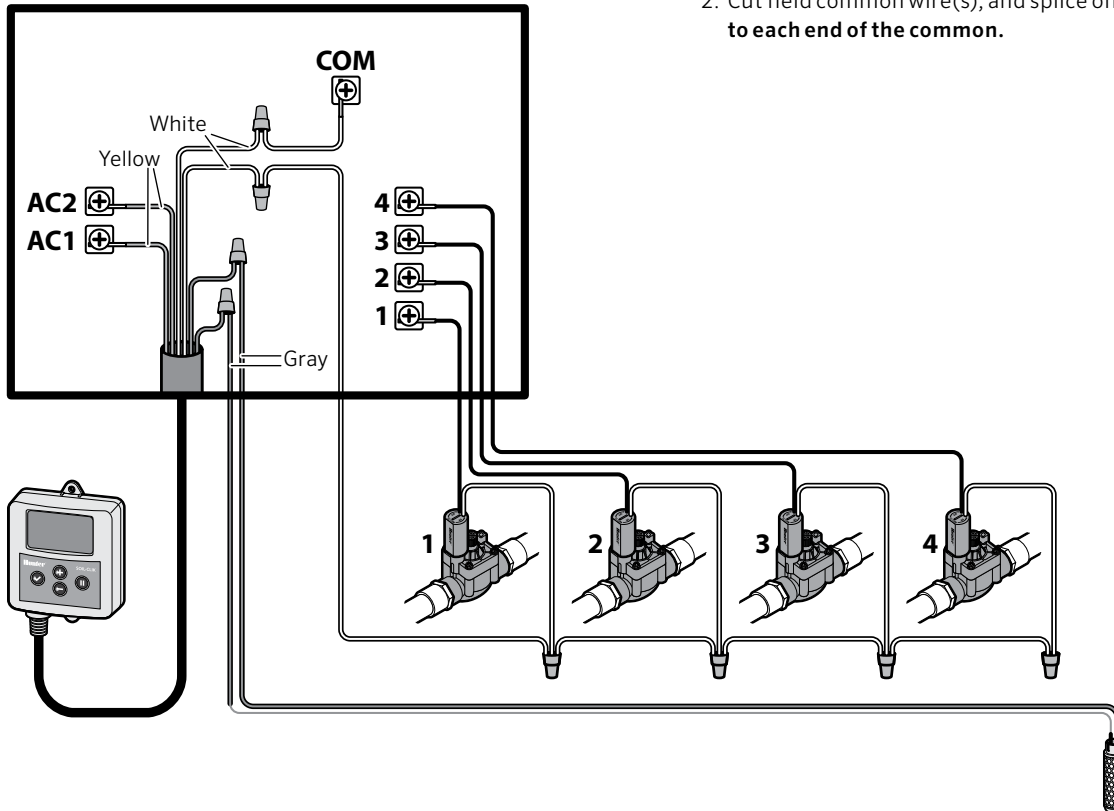

# Using Soil-Clik with Solar Sync®

Soil-Clik is ideal when installed together with Hunter Solar Sync. Solar Sync adjusts run times for weather conditions, and provides rain and freeze shutdown.

Soil-Clik prevents unnecessary watering when soil is still wet.

## X-Core, Pro-C, PCC

1. Connect Solar Sync to controller sensor terminal, as usual.
2. Connect Soil-Clik as shown in “Common Interrupt” on page 17. Do not connect to SEN terminals if Solar-Sync is present.

## I-Core (version 3.0 and later)

1. Connect Solar Sync to **S1**.
2. Connect Soil-Clik white wires to **S2** (or S3 in larger capacity versions).
3. With the dial at Set Sensor Operation, assign Solar Sync (S1) by program, and Soil-Clik (S2) by station.

## ACC (version 5.0 and later)

1. Connect Solar Sync to ET terminals.
2. Connect Soil-Clik to S1, S2, S3, or S4.
3. With the dial at Set Sensor Operation, assign Solar Sync and Soil-Clik by program.

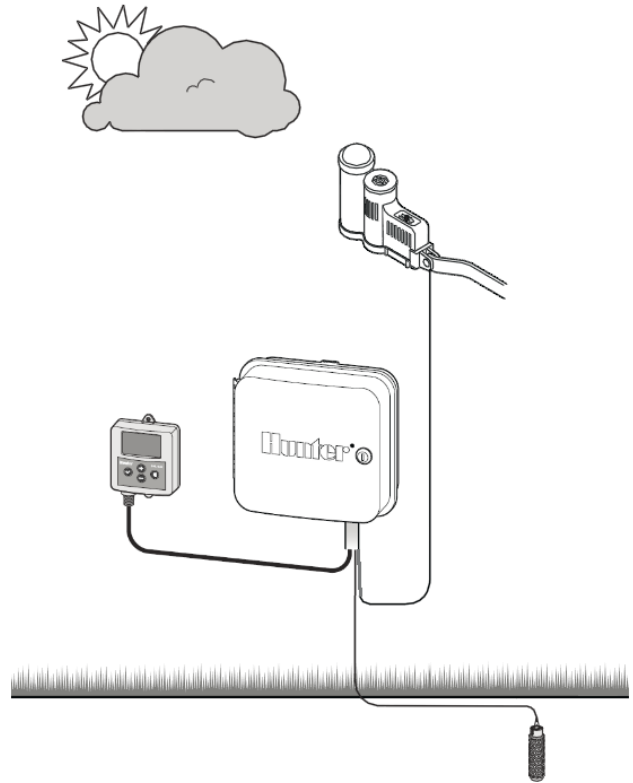

# Programming and Operations

Soil-Clik is used to set a desired moisture level. The level may be changed with the + and - buttons.

When the desired moisture has been reached, Soil-Clik will interrupt irrigation either through the controller's sensor input, or by "breaking" the common wire to the field.



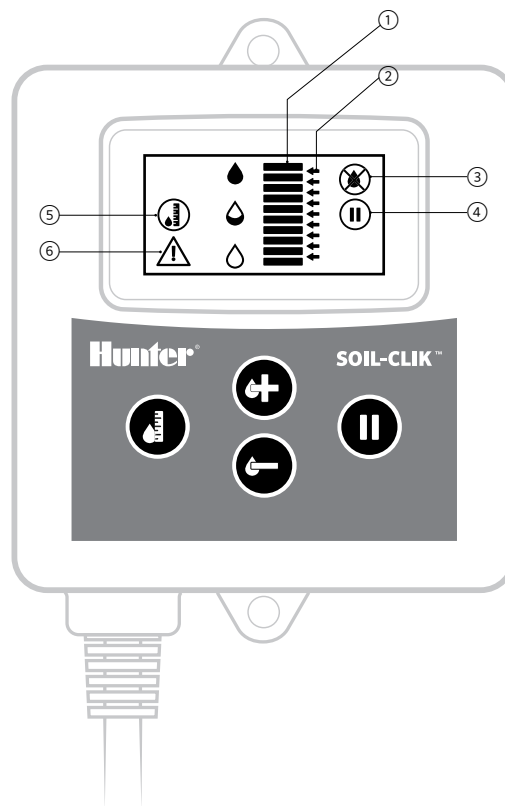





LCD Screen	
①	Moisture Level
②	Moisture Setting
③	Watering Interrupted
④	Pause/Override
⑤	Measurement
⑥	Alarm



# Programming and Operations *(continued)*



The bar steps in the display represent centibars of soil water tension on a scale of 10 to 100. High numbers indicate dry soil, or soil from which it is very difficult for plants to extract moisture.

The level of the arrows indicates the point at which irrigation will be shut off.

		0-10	Very Wet
		10-30	Sand
		30-60	Silt & Loam
		60-100	Clay
		100	Very Dry

Start with a mid-range setting based on the table or local experience.

Observe results, and adjust as needed.

Press  to increase,  to decrease.

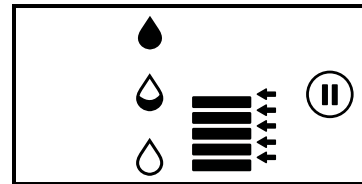

When the moisture level is reached, Soil-Click stops the irrigation. This is shown by the  symbol.

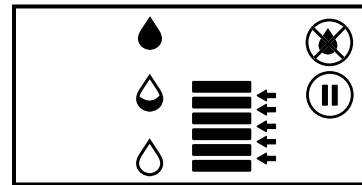

# Programming and Operations *(continued)*

**The Pause button overrides the Soil-Clik.** It will allow the controller to water normally, even if the soil moisture level has been reached.

When it is in Pause mode, the Pause symbol is shown and the rest of the screen is blank.

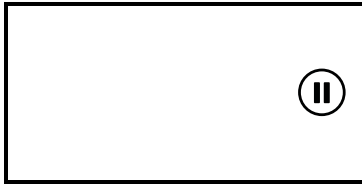

 **Pause does not pause watering. It overrides the Soil-Clik, and allows watering.**

Press Pause again to return to normal operation.

Press the  (Measurement) button to update the moisture level reading. The Measurement icon will appear. An updated measurement (bars) will appear within 5 seconds.

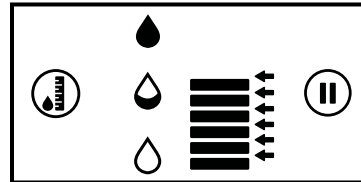

**The Alarm symbol shows an internal malfunction.** Replace the Soil-Clik Module if this occurs.

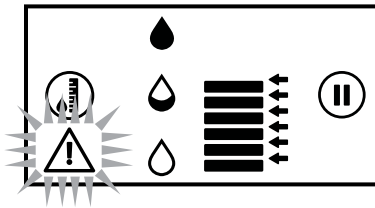

# Troubleshooting Guide

---

<b>Problem</b>	<b>Cause</b>	<b>Solution</b>
<b>Plants are too dry.</b>	Moisture level setting too low. Sensor in wrong location.	Increase arrows (+ button). Move sensor or valve wires; sensor must be in last zone to water.
<b>Plants are too wet.</b>	Moisture level setting too high. Sensor in wrong location. Pause mode has been set.	Decrease arrows (- button). Move sensor to a sunnier location. Turn off Pause.
<b>Moisture level seems incorrect.</b>	Incorrect sensor installation/placement.	Ensure full soil contact with sensor. Check sensor wiring.
<b>Moisture always at max or minimum.</b>	Failed sensor.	Use handheld sensor meter to verify operation.
<b>Alarm Symbol is displayed.</b>	Module failure.	Replace Module (Part No. <b>SC-MOD</b> ).
<b>Module display is blank.</b>	Power failure.	Check power connection to host controller.

For more detailed information, application notes, or assistance, please visit us at [www.hunterindustries.com](http://www.hunterindustries.com).

# Certificate of Conformity to European Directives

---

Hunter Industries declares that the Soil-Clik complies with the applicable standards of the European Directives at the time of manufacture, including EN 61000-6-1 and EN 61000-6-3.



Senior Regulatory Compliance Engineer



## FCC Notice

This equipment generates radio frequency energy and may cause interference to radio and television reception. It has been type tested and found to comply with the limits for a Class B computing device in accordance with the specifications in Subpart J of Part 15 of FCC Rules, which are designed to provide reasonable protection against such interference in a residential installation. However, there is no guarantee that interference will not occur in a particular installation. If this equipment does cause interference to radio or television reception, which can be determined by turning the equipment off and on, the user is encouraged to try to correct the interference by one or more of the following measures:

- Reorient the receiving antenna
- Move the controller away from the receiver
- Plug the controller into a different outlet so that controller and receiver are on different branch circuits

If necessary, the user should consult the dealer or an experienced radio/television technician for additional suggestions.

---

**HUNTER INDUSTRIES INCORPORATED** | *Built on Innovation*<sup>®</sup>

1940 Diamond Street, San Marcos, California 92078 USA

[www.hunterindustries.com](http://www.hunterindustries.com)

LIT-609\_EN A 10/14